



MEZON evo

**ELECTRONIC SPEED CONTROLLER
FOR BLDC MOTOR**

EN

User manual



**Setup
DC/DS**

1. Introduction	4
2. Connecting the controller to the receiver	5
2.1. Recommended connection for R4-R18 EX or REX series receivers	5
2.2. "All by one cable" connection suitable for R4-R18 EX or REX series receivers	6
2.2.1. MEZON EVO OPTO	7
2.2.2. MEZON EVO BEC	7
2.3. Recommended connection for older receivers of the R4-R18 series	8
2.4. Recommended connection for other RC systems	9
3. MEZON EVO settings – connection options	10
3.1. Setting the MEZON EVO controllers via the JETI Duplex DC/DS transmitter	10
3.2. Setting MEZON EVO controllers by a computer	11
3.3. Setting the MEZON EVO controllers by the JETIBOX	13
4. Quick setting	13
4.1. Quick setup by a JETI Duplex transmitter or JETI Studio program	14
4.1.1. Select a model type	14
4.1.2. Controller settings	14
4.1.3. Motor settings	15
4.1.4. Brake setup	16
4.1.5. Governor setup	18
4.1.6. Limits & Protections	18
4.1.7. BEC voltage setting	21
4.1.8. Confirm settings	21
4.2. Quick setting via the JETIBOX	22
5. Expert menu	23
5.1. Vehicle type	23
5.2. Controller	24
5.2.1. Start acceleration	24
5.2.2. Response	25
5.2.3. Direction mode	25
5.2.4. Fail-Safe Delay	25
5.2.5. Fail-Safe Mode	26
5.2.6. Stop motor beep mode	26
5.2.7. Input control	26
5.2.8. EX Bus control	27
5.2.9. Init point type	29
5.2.10. Offset adjustment	29
5.2.11. RPMmax (gear out)	30
5.2.12. Initial point	31

5.2.13. End point	31
5.2.14. Start point	31
5.2.15. Gear ratio	31
5.3. Motor	32
5.3.1. Rotation	32
5.3.2. PWM frequency	32
5.3.3. Start power	32
5.3.4. Timing.....	32
5.3.5. Number of poles.....	33
5.3.6. Rotor Gear	33
5.3.7. Filtering type.....	33
5.3.8. motor KV (rpm/V).....	33
5.4. Brake	34
5.5. Limits & Protections	35
5.5.1. Accumulator type.....	36
5.5.2. Cut-off voltage per cell.....	36
5.5.3. Max. temperature.....	36
5.5.4. Elapsed capacity.....	36
5.5.5. Max. current.....	36
5.5.6. Cut-off method.....	37
5.6. Governor	37
5.6.1. User – recommended basic setup of governor.....	38
5.6.2. Expert – user defines governor control constants manually in this mode.....	38
5.7. F3A mode	41
5.8. BEC	42
6. Telemetry	43
7. Telemetry Min/Max.....	44
8. Reset to factory defaults.....	44
9. Troubleshooting	44
9.1. Firmware update.....	44
9.2. Setting the controller to run with an unknown motor.....	45
9.3. The motor is unable to reach the required revolutions when the governor is active.....	46
9.4. Motor beeps and cannot start.....	47
10. Attachments	47
10.1. Table of preset values of individual modes	47
10.2. Dimensions of MEZON EVO controllers.....	49
Declaration of Conformity	53

MEZON

evo

1. Introduction

MEZON EVO is a series of controllers in aluminium cases* with efficient cooling, full telemetry and advanced functions. By using modern components and effective cooling over the entire surface of the metal box, the controllers achieve higher performance while maintaining maximum reliability. To set up the controller, the user can choose between the intuitive and simple "**Quick Setup**" mode and the "**Expert Mode**", with full access to all controller setting options. **MEZON EVO** is a completely universal controller for models of airplanes, helicopters, ships and vehicles for users not only of JETI Duplex transmitters, but also of all other RC systems.

Features:

- full EX telemetry (**voltage, current, capacity, revolution**, etc.)
- setup of device through **EX Bus** communication from JETI Duplex transmitter
- accurate **governor** and full support of helicopter models
- **F3A** mode for acrobatic planes
- adjustable brake with back energy recovering into accumulator
- powerful **BEC** with adjustable output voltage
- wide range of supply voltage 2 - 12 Li-XX (max. 51V)
- **bidirectional** motor run is possible
- active proportional brake
- compatible with all RC systems
- effective cooling
- compact dimensions
- "**Quick setup**" function with a user-friendly wizard
- "**Expert mode**" with full access to all controller programming options

Basic parameters of MEZON EVO controllers

	40 LMR*	70 LMR*	50 BEC	80 BEC	85 OPTO
Weight [g]	75	85	109	120	83
Dimensions [mm]	83 x 26 x 18	83 x 26 x 18	85 x 28 x 22	85 x 28 x 25	85 x 28 x 20
Current [A]**	40 (max. 30s)	70 (max. 30s)	50	80	85
Telemetry	Yes	Yes	Yes	Yes	Yes
Operational temperature [°C]	-10 up to +85	-10 up to +85	-10 up to +85	-10 up to +85	-10 up to +85
Supply voltage [V]	6 - 51	6 - 51	6 - 51	6 - 51	6 - 51
Number of cells Li-XX	2 - 12	2 - 12	2 - 12	2 - 12	2 - 12
BEC	Yes	Yes	Yes	Yes	No
BEC Current average/peak (1s) [A]**	15/30	15/30	15/30	15/30	-
BEC Voltage [V]	5 - 8.4	5 - 8.4	5 - 8.4	5 - 8.4	-
Resistance in conducting state [mΩ]	1.9	0.95	2.4	1.2	1.2
Cable cross-section (input/output) [mm ²]	2.5/2.5	4.0/2.5	2.5/2.5	4.0/2.5	4.0/2.5
OPTO (optically separated radio signal from the power management)	No	No	No	No	Yes
Cover	Shrink tube	Shrink tube	Aluminium Case	Aluminium Case	Aluminium Case

* **LMR (Limited Motor Run)** - the controller is especially designed for lowest possible weight. This series is not in a aluminium box and is intended primarily for glider models where continuous motor run is limited to a few seconds followed by a cooldown of the controller. The SW of the controller does not limit the running time, it only monitors the maximum temperature to prevent the controller from being destroyed by overheating. It is the pilot's responsibility to ensure a adequate mode of operation.

** the values are correct if the controller is cooled by flowing air

2. Connecting the controller to the receiver

The controller can be connected to the receiver in the following ways:

2.1. Recommended connection for R4-R18 EX or REX series receivers

- this is the basic and recommended connection for the currently manufactured series of receivers
- the black connector of the controller connected to the servo output (receiver) intended for throttle
- the red connector of the controller connected to the input of the receiver **Ext., E1 or E2**.
- if you use output **E1 or E2**, it have to be set as "EX Bus" communication
- input Ext. in **REX** series receivers, it has **automatic detection** and does not need to be configured
- input Ext. for older receivers of the **Rx** series, set to "EX Bus" in the "Main Menu/model/device explorer/Rx receiver/Serial line"

- this connection, first cable transmits information regarding the position of the throttle stick (black connector), the second transmits telemetry data and instructions for setting the controller from the transmitter (red connector)
- both cables are used for power supply of the receiver and servos from the BEC (doesn't apply to the "Opto" version).

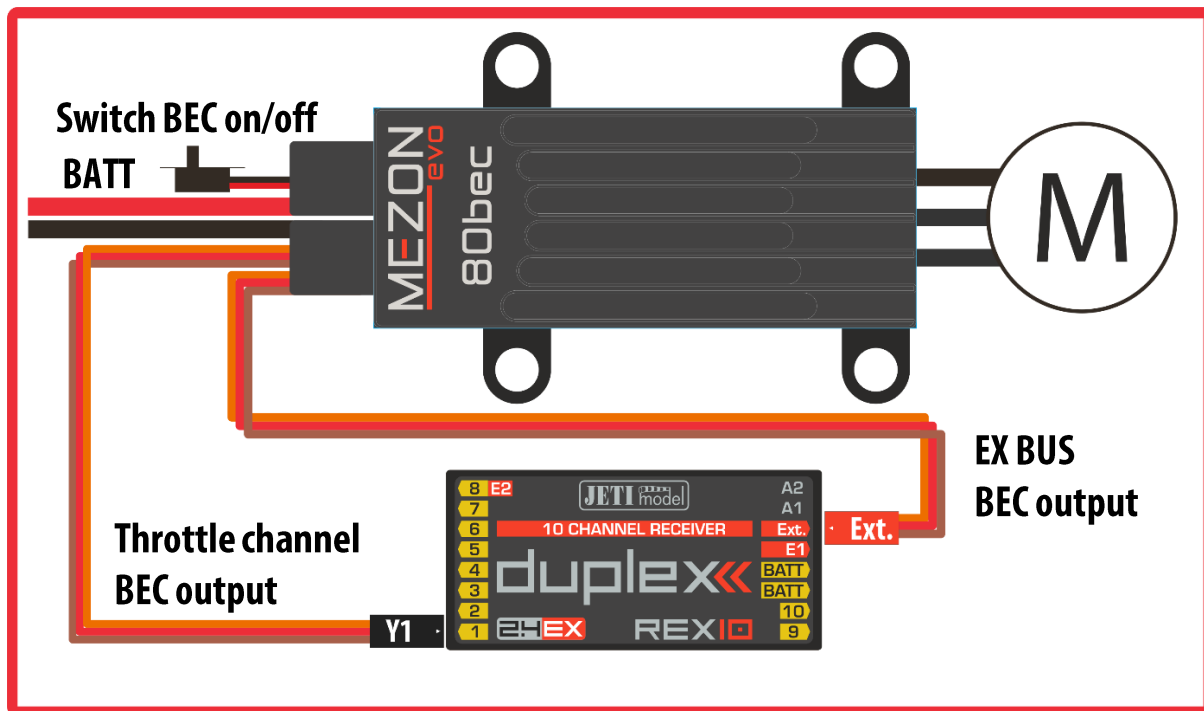

- **MEZON EVO OPTO** controllers have optically separated inputs and are not equipped with a **BEC**
- for proper operation, it's necessary to power the receiver, servos and other devices with an external battery
- instead of the battery, an external power source can be used, for example the **JETI SBEC 30D EX**, powered directly from the model's main battery

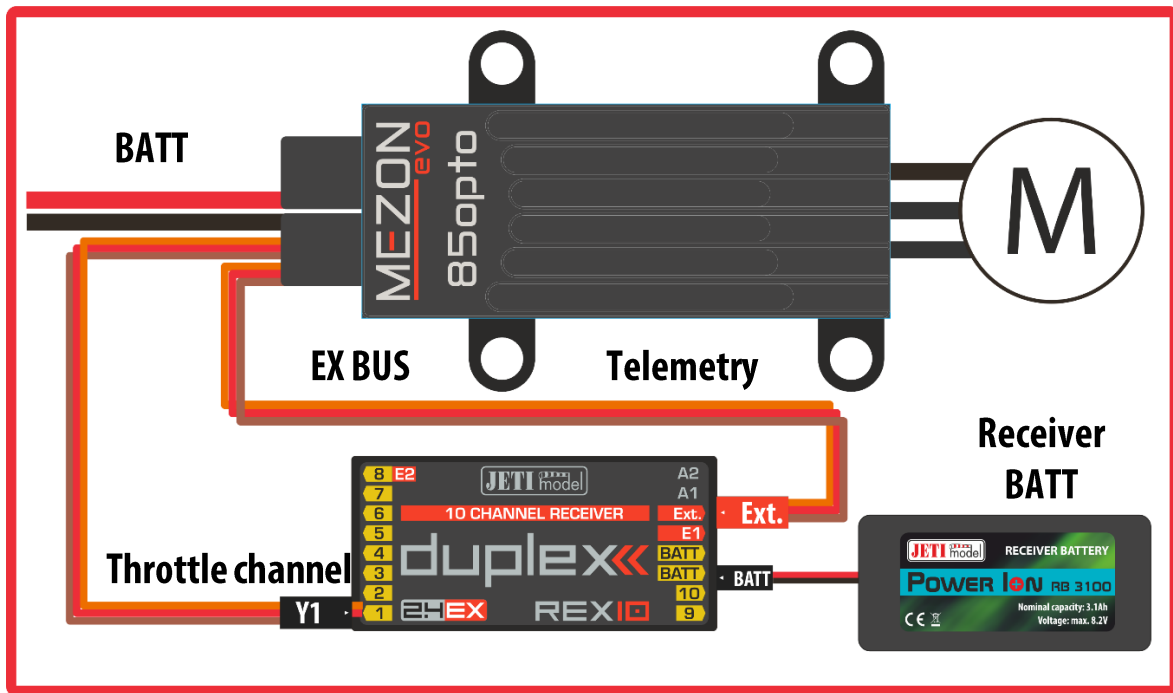

2.2. "All by one cable" connection suitable for R4-R18 EX or REX series receivers

- only one "EX Bus" serial communication cable is used for connection between the receiver and the controller
- in the controller menu "MEZON EVO/Expert settings/Controller/Input control", select the option "EX Bus control" and set it as "ON-Auto"

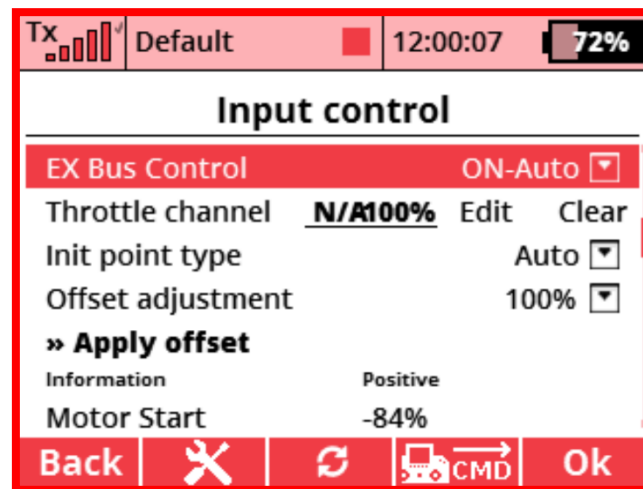

- with this connection, all information is transmitted bidirectionally via one cable (control signal and controller setting from the JETI Duplex transmitter and telemetry data to the transmitter)
- the connection is different between **MEZON EVO** (with BEC) and **MEZON EVO OPTO** (with optical separation of inputs)

2.3. Recommended connection for older receivers of the R4-R18 series

- this is the basic and recommended connection for the older manufactured series of Rx receivers
- the black connector of the controller connected to the servo output (receiver) intended for throttle
- the red connector of the controller connected to the input of the receiver Ext.
- **input Ext., set to "EX Bus"** in the "Main Menu/model/device explorer/Rx receiver/Serial line"
- first cable transmits information regarding the position of the throttle stick (black connector), the second transmits telemetry data and instructions for setting the controller from the transmitter (red connector)
- both cables are used for power supply of the receiver and servos from the BEC (doesn't apply to the "Opto" version).

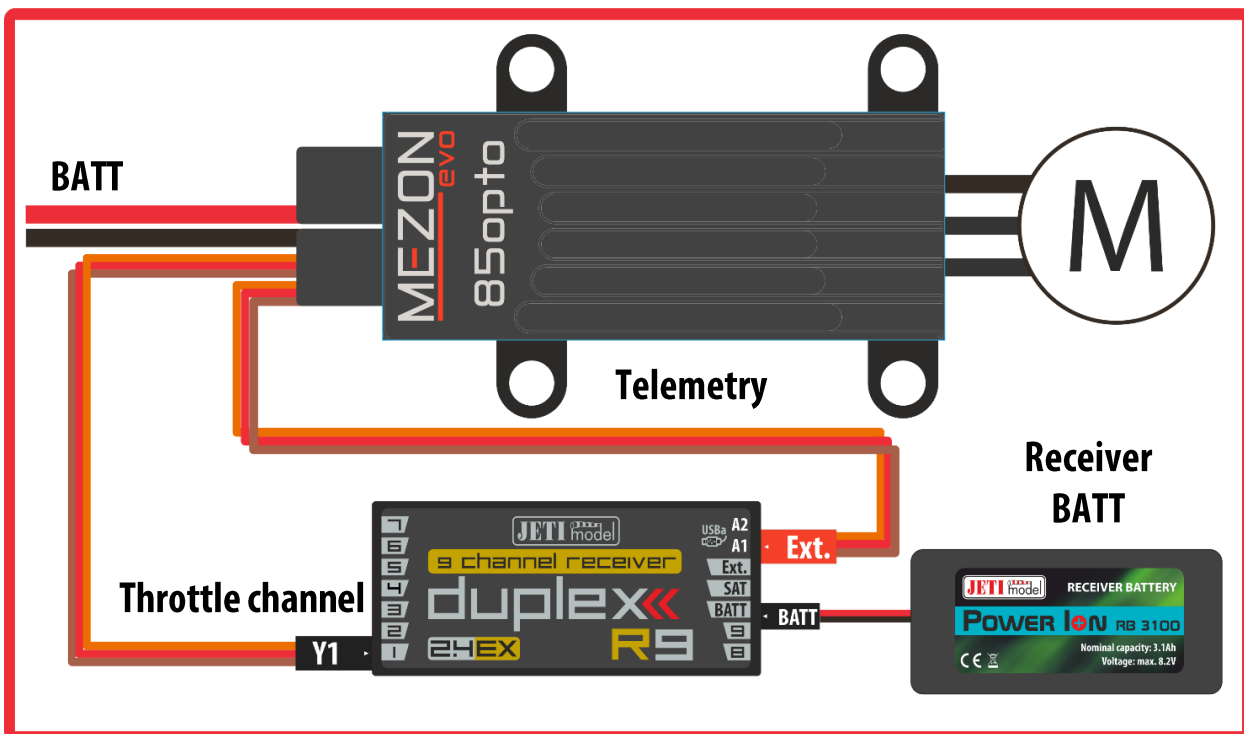
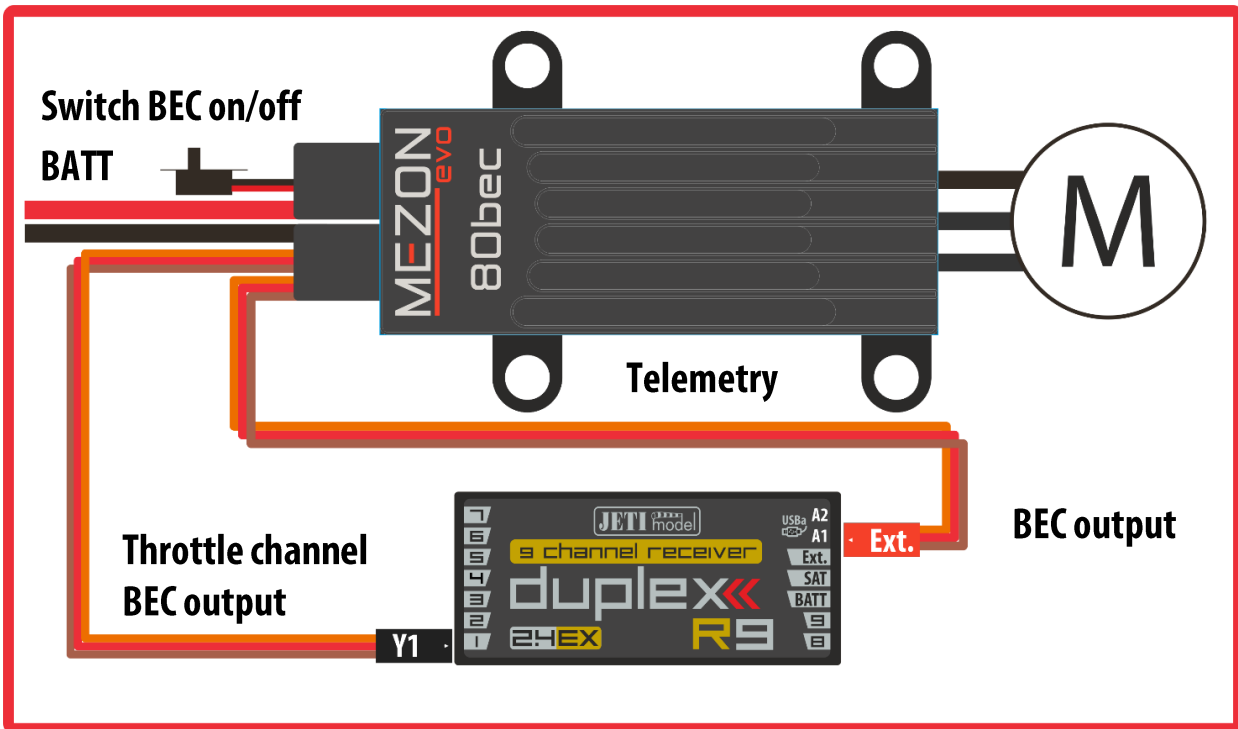

2.4. Recommended connection for other RC systems

- the **black** connector of the controller connected to the servo output (receiver) intended for throttle
- the **red** connector is not connected, by connecting the **JETIBOX** or via the **USB adapter** of a PC with the **JETI Studio program**, the controller can be set
- first cable transmits information regarding the position of the throttle stick (black connector), at the version of the controller with "BEC" also the power supply for the receiver and servos
- in the version of the regulator with "BEC", it is possible to connect the red connector to any free servo output as a power supply for the receiver and servos. In this case, we recommend removing the pin of the orange cable from the **red** JR connector, carefully insulating it and leaving it unconnected.

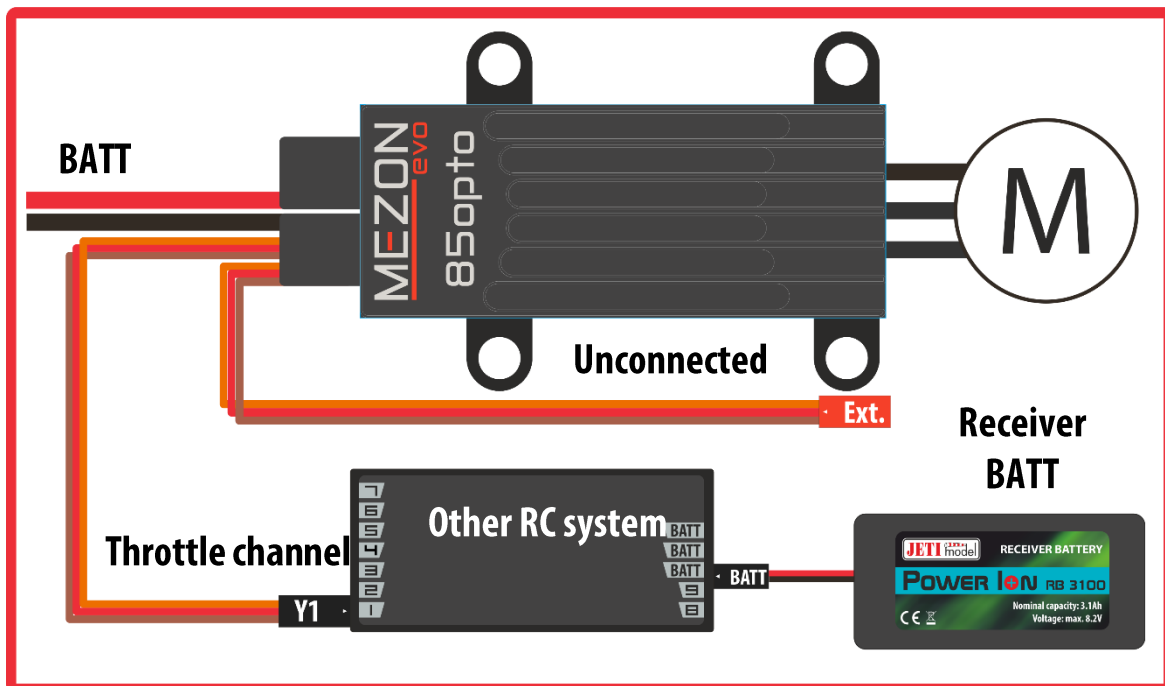
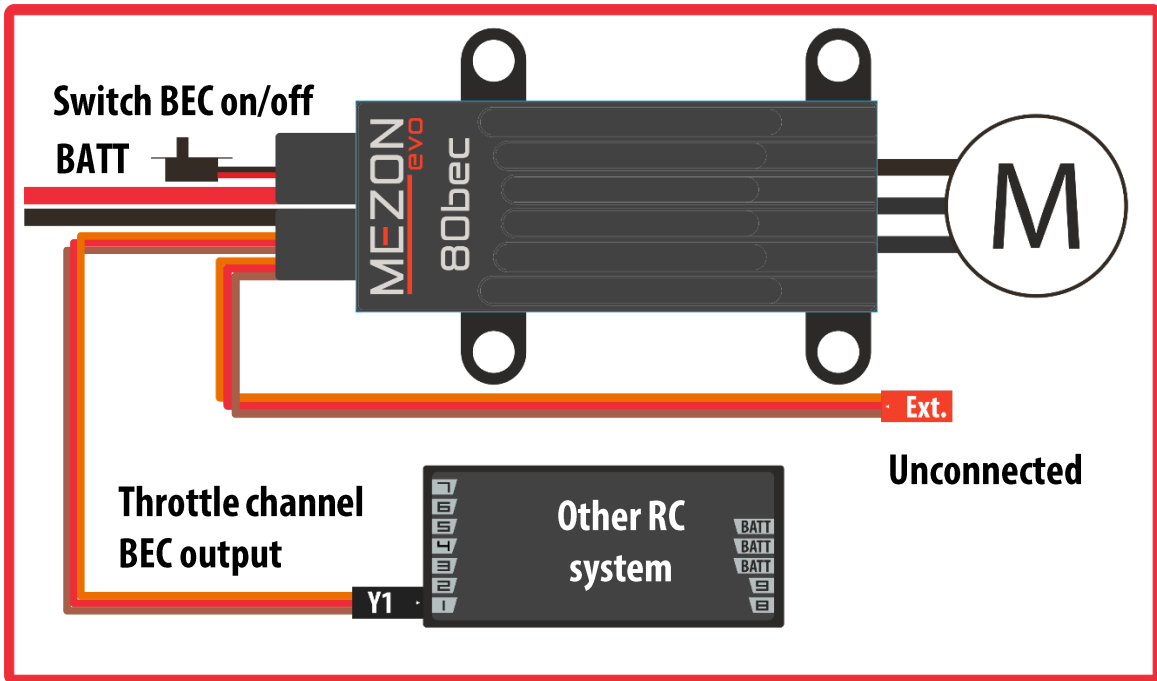

3. MEZON EVO settings – connection options

Controllers can be set directly from the JETI Duplex DC/DS transmitters, by connecting to a PC using the JETI Studio program, or via the JETIBOX. We recommend using one of the first two options. Setting via the JETIBOX terminal is possible with full options, but less comfortable due to the JETIBOX's two-line display. After connecting to one of the three mentioned devices, the controller automatically switches to the correct type of communication, so there is no need to set the communication.

WARNING - if the motor is running, the regulator setting is locked. It is therefore not possible to edit any items and make changes to the controller settings

3.1. Setting the MEZON EVO controllers via the JETI Duplex DC/DS transmitter

This is the recommended method of setting the controller for owners of the JETI Duplex DC/DS transmitters. It is user-friendly, always available and no additional devices are required.

- first check via the free available JETI Studio program (the program available at <https://www.jetimodel.cz/support/jeti-studio/jeti-studio.html>) that you have up-to-date SW in the transmitter and controller
- connect the controller to the receiver according to the previous chapter
- open the "**Menu/Model/Device explorer**" in the transmitter. The device "**MEZON EVO**" has to appear in the menu

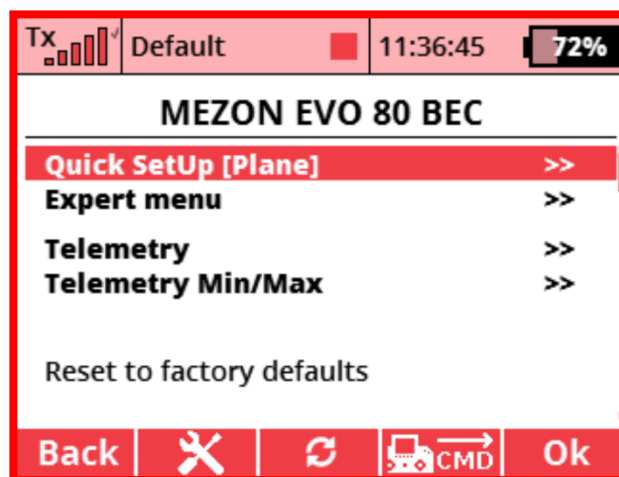
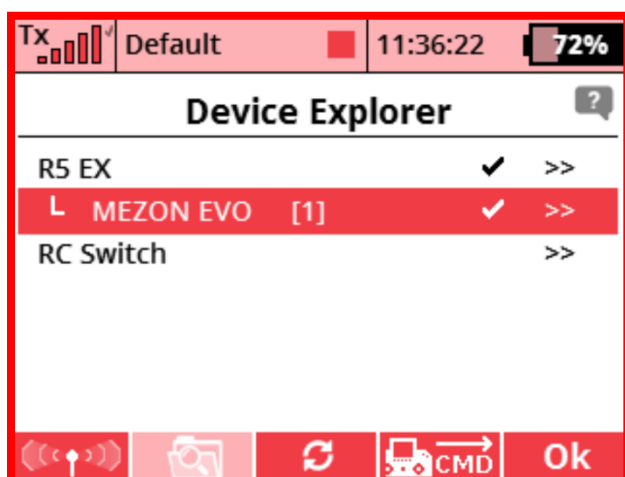

- by opening the controller item, we get to the main menu

Note: the items "**Telemetry**" and "**Telemetry Min/Max**" are described at the end of the manual (see Contents)

3.2. Setting MEZON EVO controllers by a computer

This controller setup option gives the same graphics and programming capabilities as the JETI Duplex transmitters. A "**USB adapter**" is required for connect the computer to the controller. You can buy this USB adapter at our official distributors.

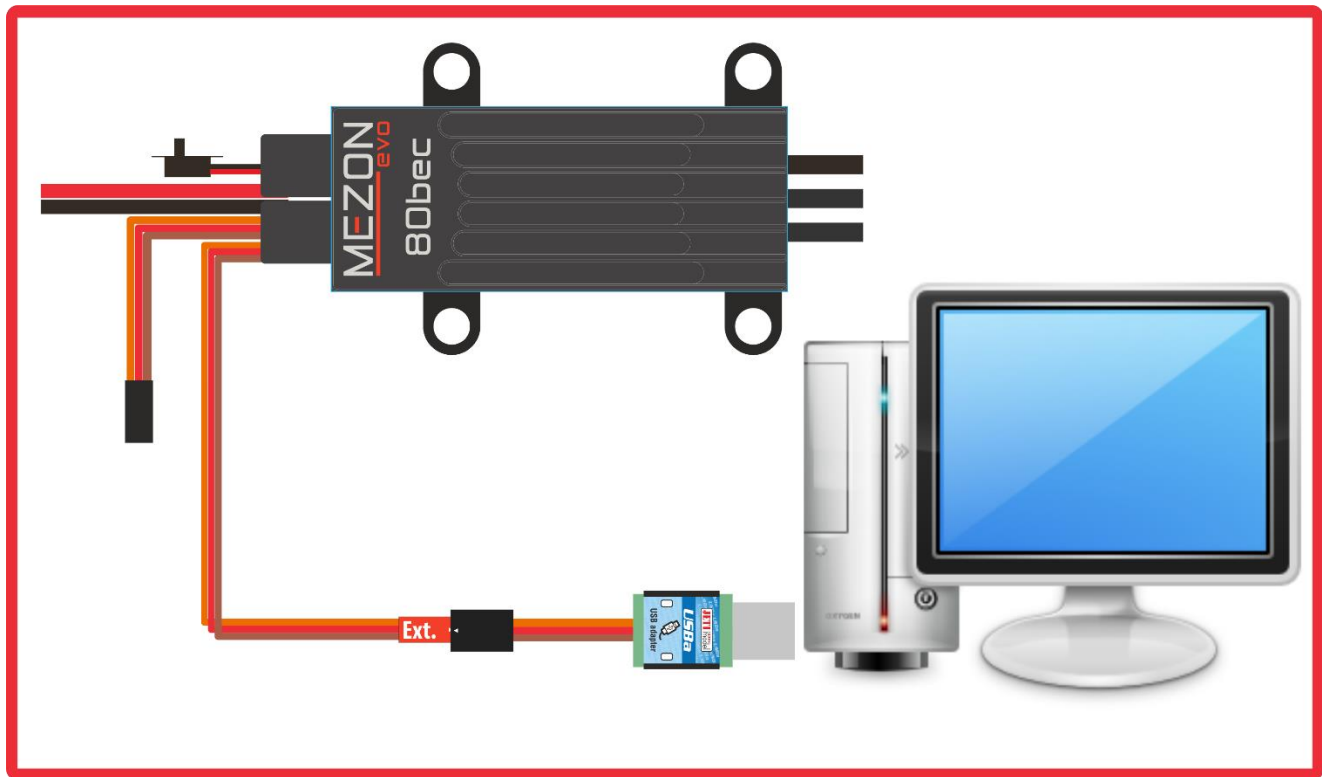

- download and install the "**JETI studio**" program to your computer. The program can be downloaded here (for free): <https://www.jetimodel.com/support/jeti-studio/jeti-studio.html>
- connect the USB adapter to a free USB port on the computer. The green LED on the USB adapter lights up after connection.
- start the JETI studio program and in the lower right corner of the program window select **correct COM port**. If the correct COM has been selected, the **red LED** on the USB adapter will start flashing (communication)
- connect the **red JR** connector of the controller to the USB adapter
- connect the **main battery** to the controller. At the version with a BEC switch, turn the **switch ON**.
- in the "**Device Explorer**" window of JETI studio, the controller name "**MEZON EVO**", its serial number and the current software version will appear

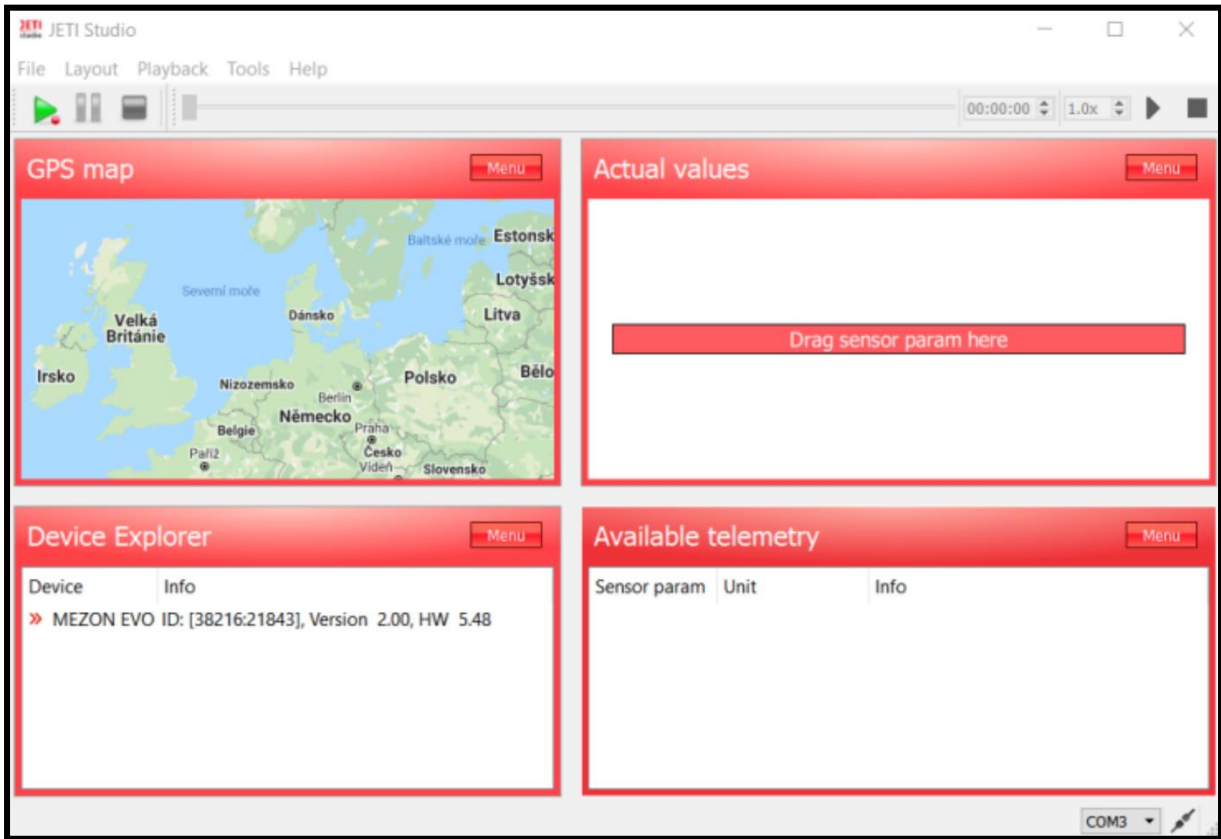

- by opening the link (**double-click**) on the controller, you will get to the “main menu” window of the controller settings

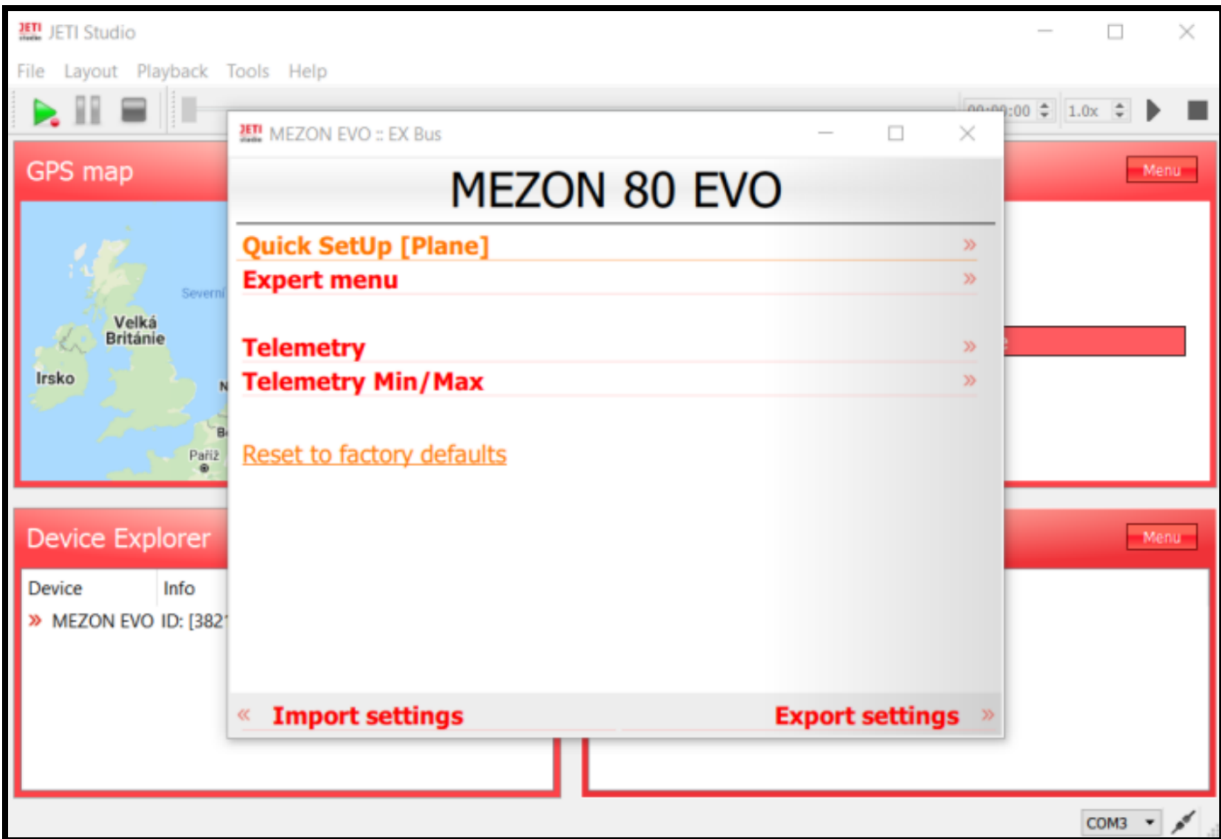

3.3. Setting the MEZON EVO controllers by the JETIBOX

This controller setting option gives the same options as the previous one, but the display is limited by the JETIBOX's two-line display. You can buy JETIBOX terminal at our official distributors.

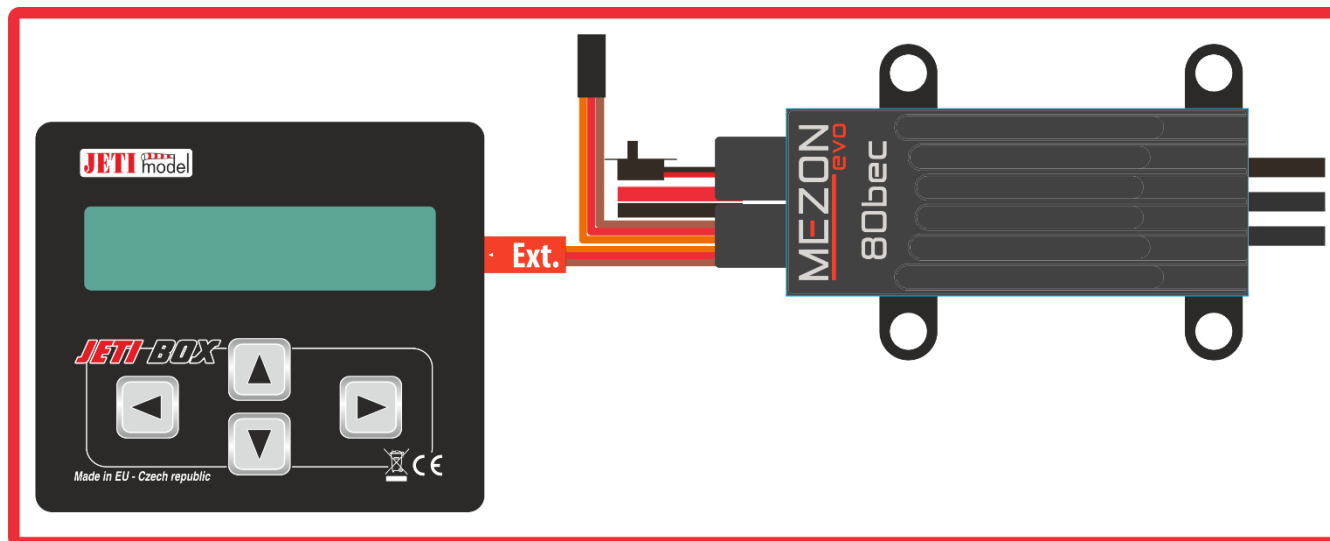

- connect the **main battery** to the controller
- connect the **red JR** connector to the bottom position of the JETIBOX
- at the version with a BEC switch, turn the switch „ON“
- at the "OPTO" version of the controller, connect a **5 - 8,4V** battery to the top position of the JETIBOX

Examples of individual items and selection of the values on the JETIBOX terminal display:

« Settings menu Controller »	< Timing 15 ° >	« SBEC Voltage 5 . 1 V »
---	--	---

4. Quick setting

MEZON EVO controllers has a lot of parameters. For that reason, the "**Quick setup**" menu is available, which will enable the controller to be put into operation easily and quickly even by a less experienced user. The "**expert setup**" enables any adaptation of the behaviour of the controller to the atypical requirements of the user or the special needs of the exact model.

Both menus can be combined. This means that we can set the controller for a specific model using the wizard in "**Quick Setup**" and fine-tune only selected parameters via "**Expert Setup**".

4.1. Quick setup by a JETI Duplex transmitter or JETI Studio program

4.1.1. Select a model type

In the main menu, select the item "Quick setup". The currently selected model type is shown in square brackets. By default, it is the [Plane] model. If the model type is changed, the controller beeps 5 times as a warning that the engine start protection has been activated. This protection means that the motor cannot be started while the controller is being adjusted. **However, we recommend always having the throttle lever in the engine off position and removing the propeller or rotor blades while adjusting the controller.**

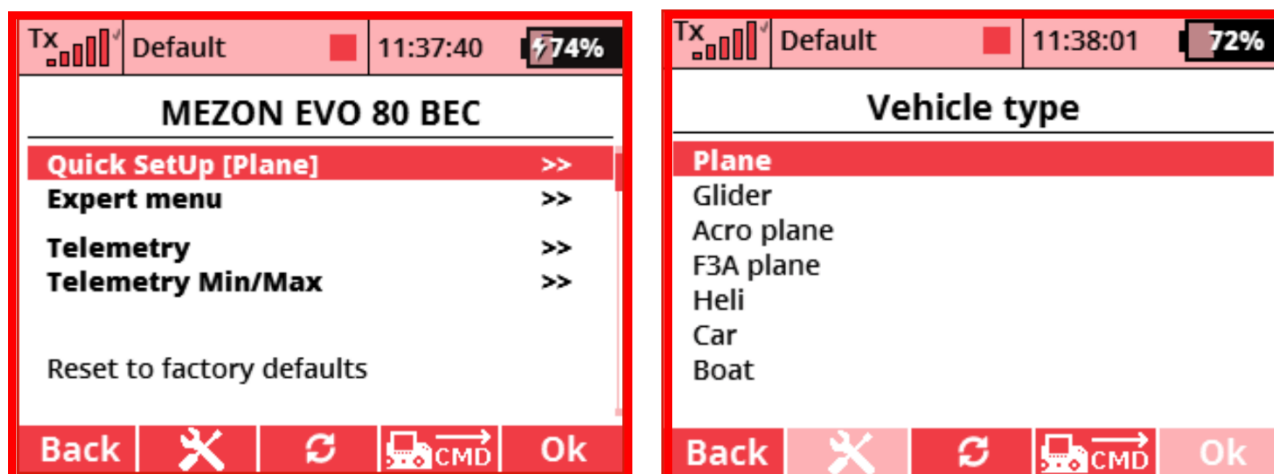

On the next screen, select the exact type of the model. According to the selected type of model, the controller parameters are automatically pre-set to optimal values. If necessary, a detailed values are shown in the table at the end of the manual.

Note: as soon as we select and confirm the model type, the menu of the following items and controller setting options will also be adapted. To simplify the menu, only items that are logical and usable for each type of model are displayed and available in next steps.

Example: if we select the "Glider" model, we will not find items related to governor settings in the following menus.

4.1.2. Controller settings

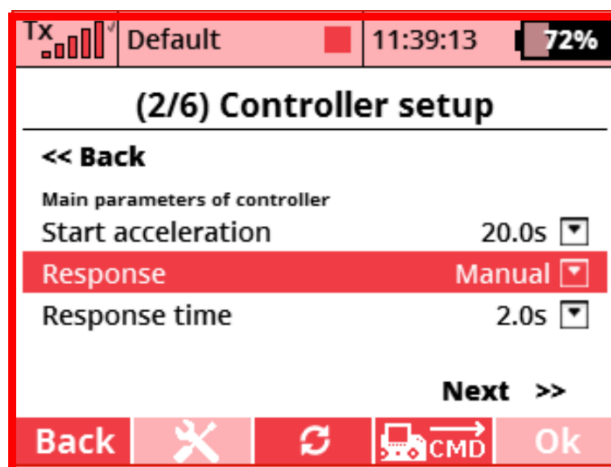

Start acceleration: the time it takes for the motor to start up to the requested RPM after switching on the controller by a command from the throttle channel, i.e. mostly from zero RPM. As soon as the motor reaches the required speed (**throttle position**), the motor response is switched to the value defined by the "Response" parameter. If the controller is switched off during the flight, i.e. the throttle stick is pulled to stop, the next motor command will follow the "Start acceleration" value again. **Note:** for helicopter models, the behaviour described above is affected by the autorotation mode setting, see detailed description in "**Autorotate Mode**".

Response: how fast a running motor reacts to a throttle change

Normal: "Response time" parameter is the same as "**Start acceleration**"

Fast: the shortest possible time set by the controller, **approx 0.2s**

Manual: possibility to manually set the response time in the "**Response Time**" parameter

4.1.3. Motor settings

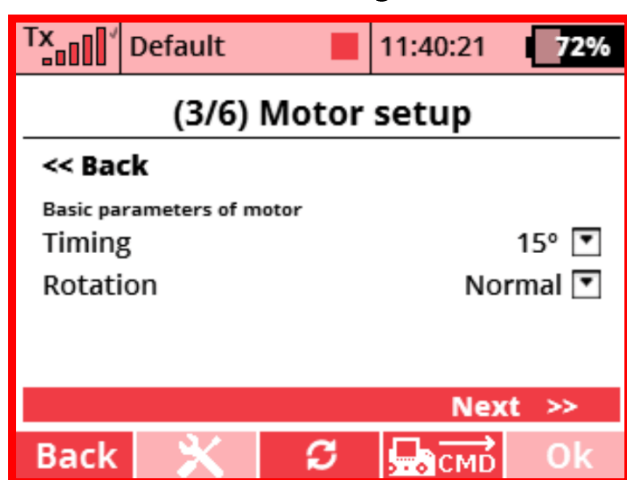

menu for model: Plane

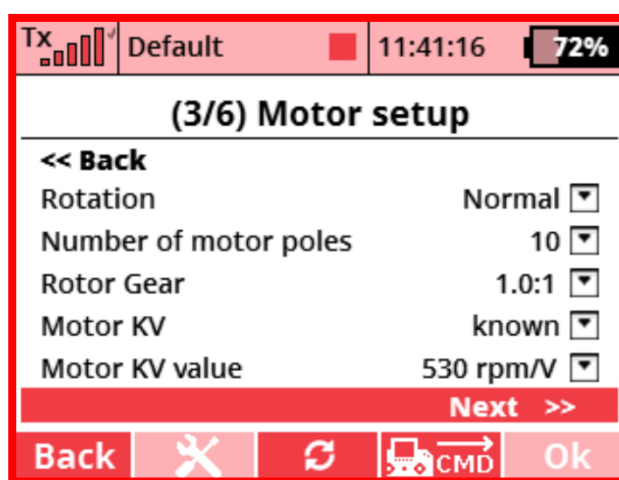

menu for model: Helicopter

Timing: select the timing value according recommendation from the motor manufacturer

Rotation: possibility to change the direction of rotation of the motor

For the correct function of the governor on the helicopter model, it is also necessary to set:

Number of poles: the number of poles of the electric motor specified by the manufacturer. This data is used to correctly calculate the engine speed

Rotor gear: the gear ratio between the motor and the rotor

Motor KV: if you know the motor's Kv, select "known" and enter the value in "Motor KV Value". Otherwise, choose "**unknown**". The controller will calculate the expected KV value.

Note: data such as the number of poles and KV of the motor are standard parameters provide by motor manufacturers. We recommend using these parameters from the engine manufacturer. This optimizes the governor function and speed of the regulation. If the controller calculates these parameters automatically, their complete accuracy is not guaranteed. If your model is equipped with a completely unknown motor, it is possible to determine these parameters by simple measurements. **See chapter "Troubleshooting, part of the controller settings for running with an unknown motor".**

4.1.4. Brake setup

Note: this menu is not available for the helicopter model

The MEZON EVO controller has four fixed pre-set brake profiles: "Off, Soft, Medium and Hard". These four basic brake profiles are extended by the "Manual" and "Proportional" profile. In "Manual" mode, the brake profile can be set manually by the user. In "Proportional" mode, the braking effect of the motor depends on the position of the throttle stick.

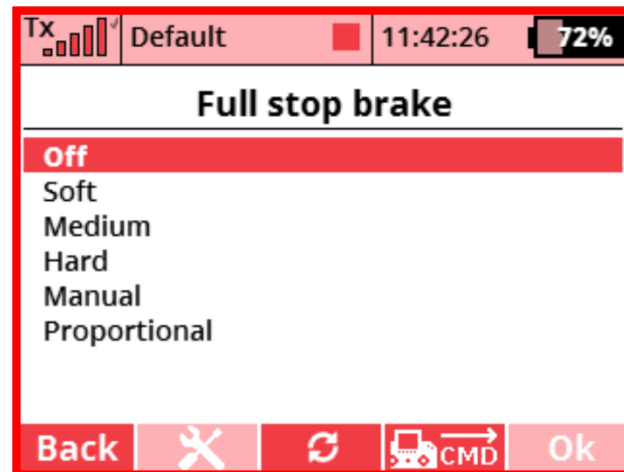

Off – the motor brake is off, so the motor will not brake

Soft - fixed value:

Begin power	30%
End power	100%
Dead time	0,5s
Speed	1,5s

- the brake starts braking with a delay of 0.5s from its activation, with an initial effect of 30%, which increases up to 100% during 1.5s.

Medium - fixed value:

Begin power	50%
End power	100%
Dead time	0,5s
Speed	1s

- the brake starts braking with a delay of 0.5s from its activation, with an initial effect of 50%, which increases up to 100% during 1s.

Hard - fixed value:

Begin power	70%
End power	100%
Dead time	0,5s
Speed	0,5s

- the brake starts braking with a delay of 0.5s from its activation, with an initial effect of 70%, which increases up to 100% during 0.5s.

Manual - the values are fully adjustable by the user

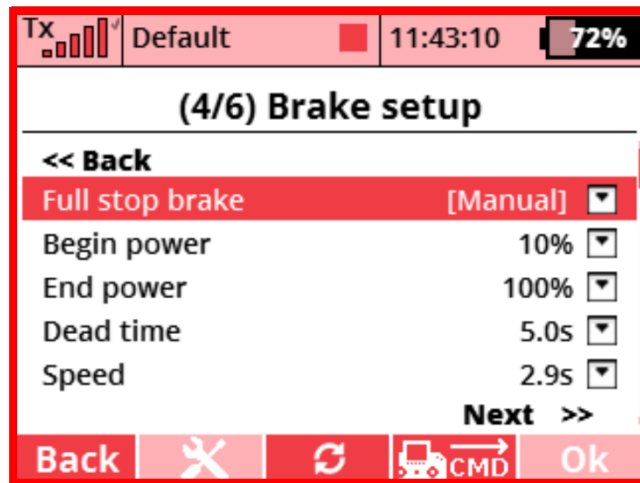

All values are fully adjustable by the user in this range:

Begin power	0 - 100%
End power	0 - 100%
Dead time	0 - 5s
Speed	0,1 - 10s

Proportional – in this profile, the braking effect of the motor depends on the position of the throttle stick, so it is possible to control not only the motor power, but also the brake intensity by the throttle stick.

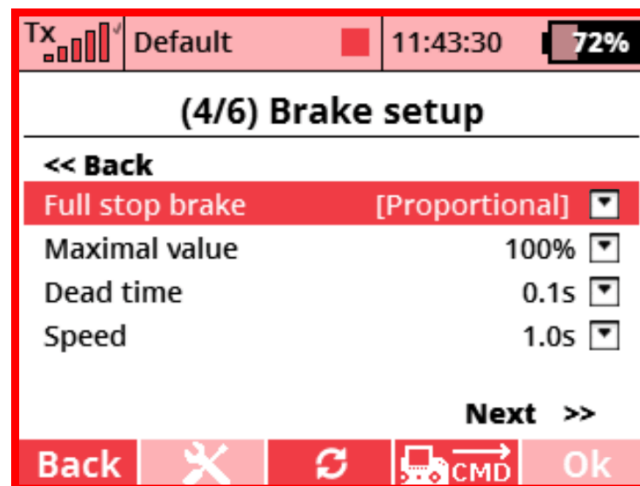

For proportional brake, additional values have to be set:

Maximum power - the parameter is adjustable in the range of 10-100%. Determines the braking effect of the motor when the throttle stick is in the minimum position.

Dead time - the parameter is adjustable in the range of 0-5s. Determines the time it takes for the brake to be activated after the throttle stick is in the minimum position.

Speed - the parameter is adjustable in the range of 0.1-10s. Determines the time between the start of braking and reaching "Maximum Power" of the brake.

4.1.5. Governor setup

Note: this menu is only available for the helicopter

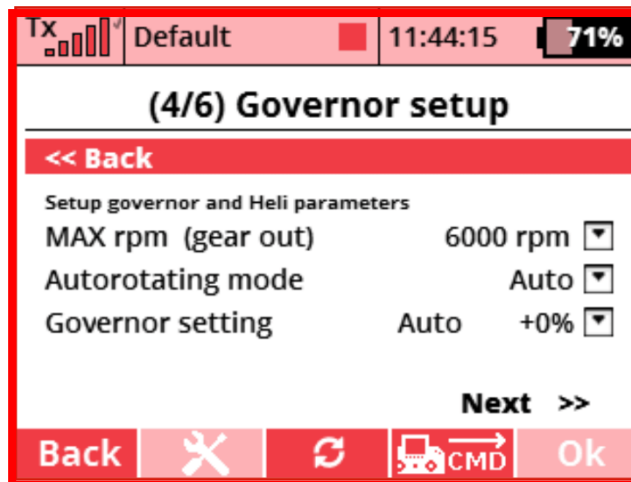

Max rpm (gear out) – maximum RPM at the gearbox output. Enter the value of the recommended speed of the rotor blades according to the manufacturer of the helicopter model. Controller automatically calculates and sets the required motor speed according to the gear ratio and number of motor poles you entered. The adjustable rotor speed range is 100-65500 rpm. / min.

Autorotating mode – if you want to use the autorotate function, select its function mode.

OFF

Auto

Range

Range + Time (adjustable max. autorotation time)

For a detailed explanation, see chapter list of parameters.

Governor setting – setting the intensity and speed regulation during changes of the load. The higher the numerical correction + xx%, the faster and harder the speed regulation. For classic flying, it is quite suitable to set the value Auto + 0%. With advanced aerobatic features, you may need to increase the upward correction value as well.

For a detailed explanation, see chapter list of parameters.

4.1.6. Limits & Protections

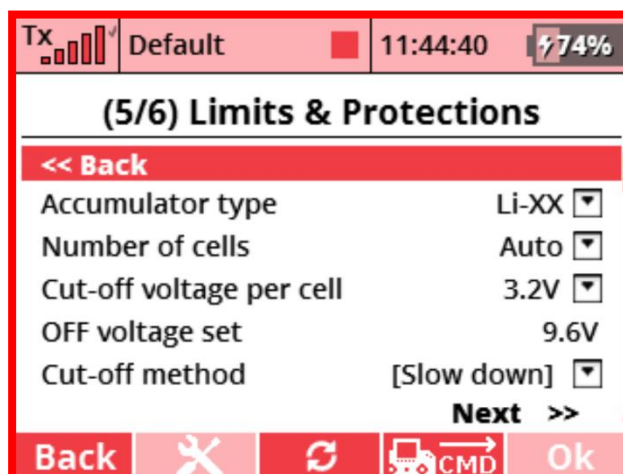

Battery type – choose according to the type of main batteries. Available options are "Ni-XX" (NiMH or NiCd batteries), "Li-XX" (Li-ion or Li-po batteries) or freely user-settable values in "Manual" mode.

Note: a correctly set cut-off voltage of the controller protects the battery from complete discharge and thus from destroying or reducing the "life-time" of the battery. The factory setting of the controller for cut-off voltage is the option to automatically recognize the number of Li-XX cells with a cut-off voltage of 3.2V per cell. Automatic mode works correctly only when you connect fully charged batteries to the controller!

Battery type „Ni-XX“

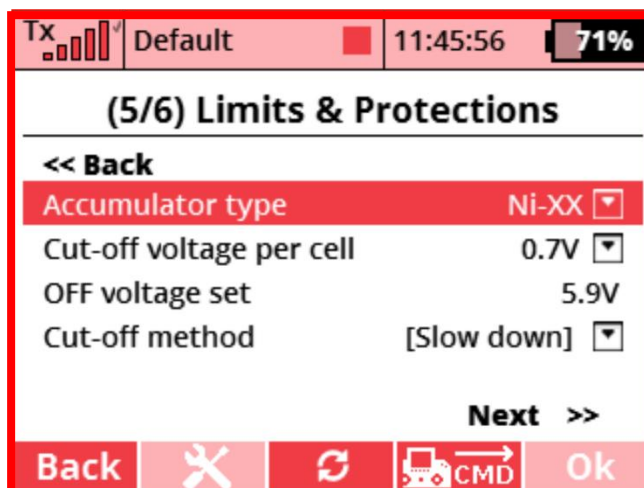

Cut-off voltage per cell – setting the minimum voltage value per cell of the battery. At this limit, battery protection is activated. The factory setting is 0.7V.

Cut-off voltage set – calculated values of the minimum battery voltage. At this limit, battery protection is activated.

Battery type „Li-XX“

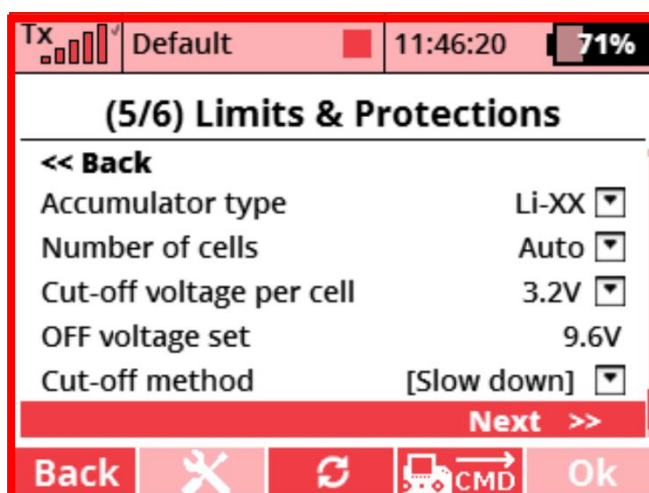

Number of cells - possible setting of 2-12 cells or "Auto". Automatic mode recognize the number of cells and controller determines their number according to the voltage of the connected battery.

Note: if it is possible that you will turn on the model without fully charged batteries, it is better to enter a fixed number of cells instead of automatically recognizing the number of battery cells.

Cut-off voltage per cell – setting the minimum voltage value per cell of the battery. At this limit, battery protection is activated. The factory setting is 3.2V.

Cut-off voltage set – calculated values of the minimum battery voltage. At this limit, battery protection is activated.

Battery type „Direct“

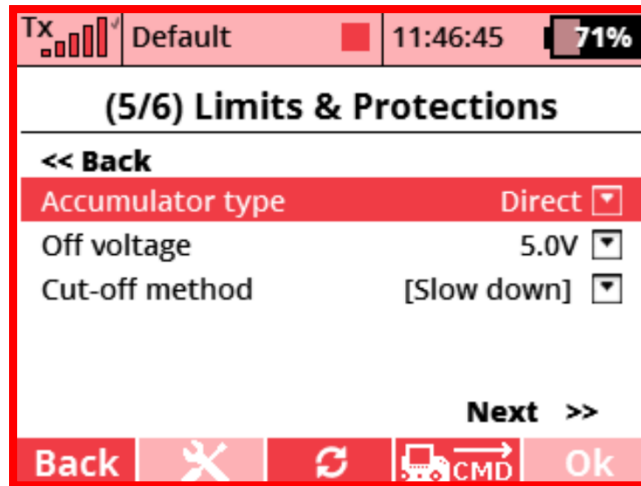

Off voltage – calculated values of the minimum battery voltage. At this limit, battery protection is activated. The adjustable range is 5-40V.

Cut-off method – the controller's reaction to reaching the minimum battery voltage (Off voltage), exceeding the set capacity, or reaching the maximum temperature

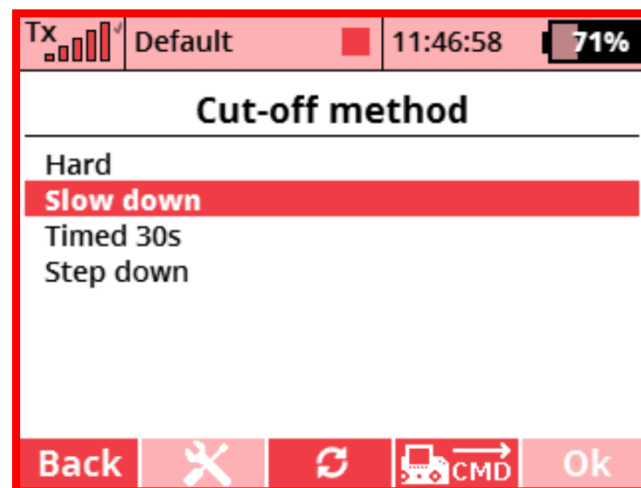

Options:

"Hard" - if the limits above are reached, the motor will stop in 2s.

"Slow down" - gradual reduction of motor power from the current speed to stop during 30 seconds.

"Timed 30s" - gradual reduction of motor power from the current speed to stop during 30 seconds. During power reduction, the limits (temperature, capacity, voltage) are checked. If the limit parameter returns to the standard operating values during the reduction of the controller's power, the process of power limitation is ended. The controller will gradually return to standard operation without limitation.

"Step Down" – if any of the above-mentioned limits (temperature, capacity, voltage) is reached, the motor speed will be reduced in steps by approx. 20%. In this way, the model signals the activation of one of the protections. For 15 seconds, the controller maintains this reduced power and thus enables a safe landing. After this time, there will be a further gradual reduction in power until the engine comes to a complete stop. This option is suitable for example for helicopters and drones.

4.1.7. BEC voltage setting

Note: this menu is only available for the controller with "BEC"

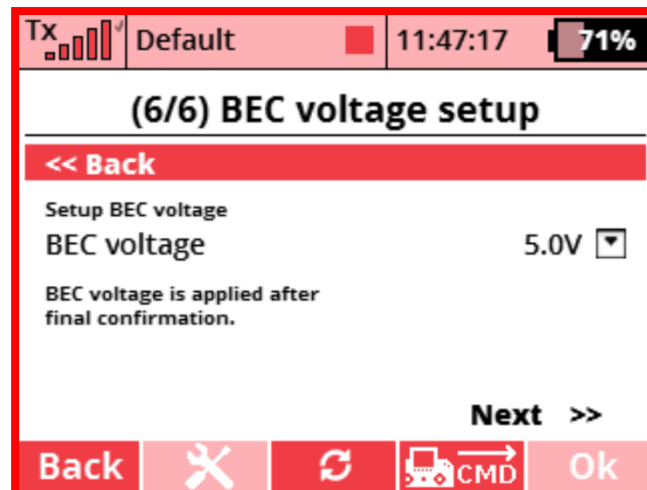

The range of possible settings of the BEC is 5-8.4V. For safety reasons, the change in the BEC voltage value is activated only after the final confirmation of the entire controller setting on the following screen.

Note: if we connect a battery with a lower voltage to the controller than is set in the "BEC voltage" parameter, the controller's voltage output will be the same as connected batteries, not as the set BEC value.

4.1.8. Confirm settings

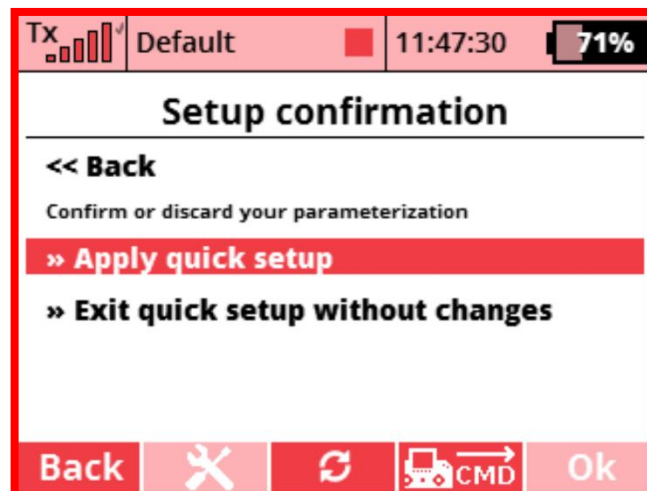

On the last "Quick Setup" screen, one of the following two options have to be selected.

Apply Quick Setup - Confirmation ends the "Quick Setup" process. The set values are saved and activated. You can start using your model.

Exit quick setup without changes - confirming this option will not save the set values. The "Quick Setup" process ends and no changes are made.

4.2. Quick setting via the JETIBOX

Description for connecting the controller MEZON EVO to JETIBOX:

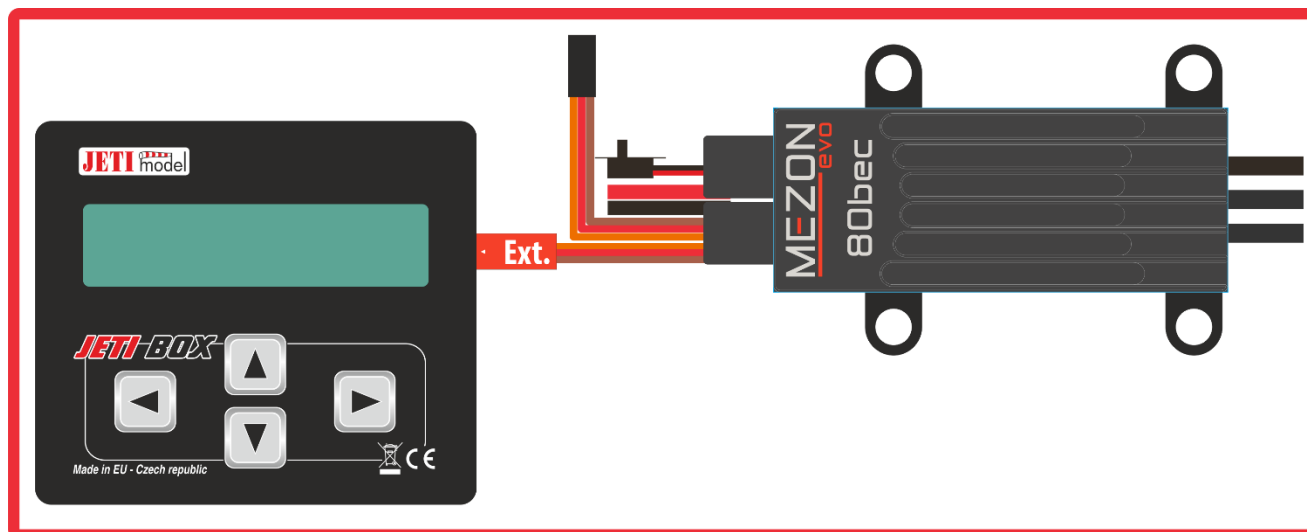

- connect the battery to the controller
- connect the cable with the red connector of the controller to the bottom connector of the **JETIBOX**
- for the controller with **BEC**, turn "ON" the BEC with a switch on the cable
- for the "**OPTO**" controller, connect the external battery (5-8.4V) to the top connector of the **JETIBOX**

- go to the "**General menu**" via the JETIBOX

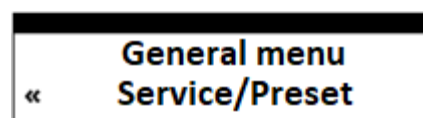

- go to the menu "**Vehicle type**" by down button and select the appropriate type of model "Aircraft/Airplane/Acrobatic Aircraft/F3A Aircraft/Helicopter/Car/Ship"



- on the **JETIBOX**, press the right and left buttons simultaneously. Hold buttons until the item is changed

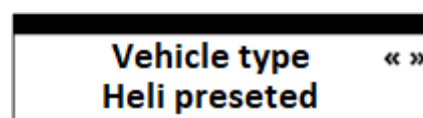

- Check and set the correct values in the "**Controller**", "**Limitations**", "**Motor**" and "**SBEC**" as described chapter above "**Quick setup via the transmitter**".

Note: if you selected the "Helicopter" model, you have to set other parameters in the menu "Special Modes" item "Governor". It is necessary to set at least the parameters: "Number of motor poles", "Motor Kv", "Gear ratio" and "Maximum required rotor speed". The controller does not work correctly without setting the above parameters.

Description of the parameters can be found in chapter "**4.1.5 Governor settings**"

5. Expert menu

- The expert menu allows the user to set all parameters individually. Menus are divided into logical submenus for better clarity.

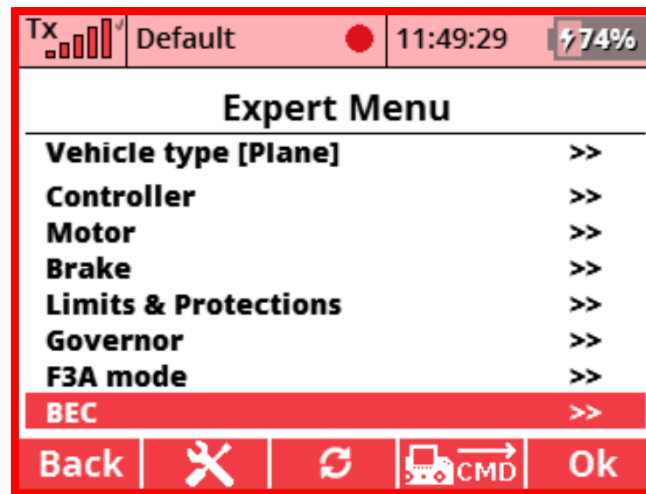

In the "**Expert menu**", all controller parameters are adjustable. The user is able to set the controller completely according to his requirements. Access to this setting is possible by selecting the "**Expert menu**" item. The menu has the following structure:

- 5.1. Vehicle type
- 5.2. Controller
- 5.3. Motor
- 5.4. Brake
- 5.5. Limits a Protections
- 5.6. Governor
- 5.7. F3A mod
- 5.8. BEC

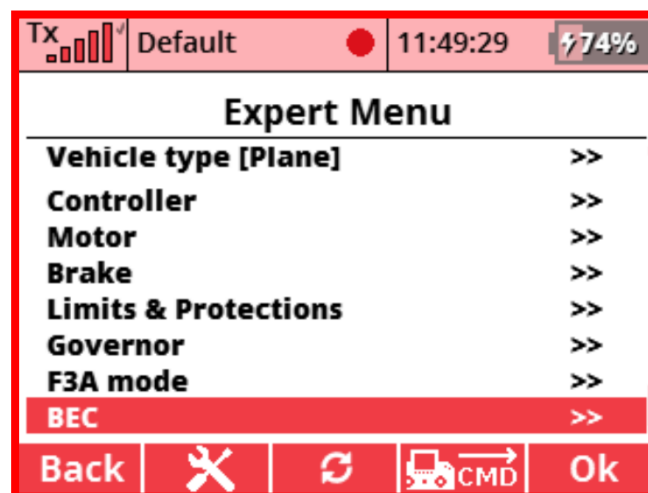

5.1. Vehicle type

- The menu is a set profiles (pre-set parameters) in the same way as described above in chapter "**Quick setup**" (4.1). In addition, it is possible to select the "**Free Config.**", which allows the user to configure free and independent of the model type. This option is suitable for applications where the possibility of the profiles is too limited (particular and uncommon applications). Selecting this item (unlike the others) does not activate any parameter pre-sets. This means that the current state of the configuration is kept.



5.2. Controller

5.2.1. Start acceleration

- the time of starting up the motor to the desired RPM after switching on the controller by a command from the throttle from zero motor RPM. Once the motor reaches the desired RPM (set by the throttle), the motor response is switched to the value defined by the "**Response**". If the motor is stopped during the flight, i.e., the throttle is set to zero, the next motor start takes the time set by "**Start acceleration**".

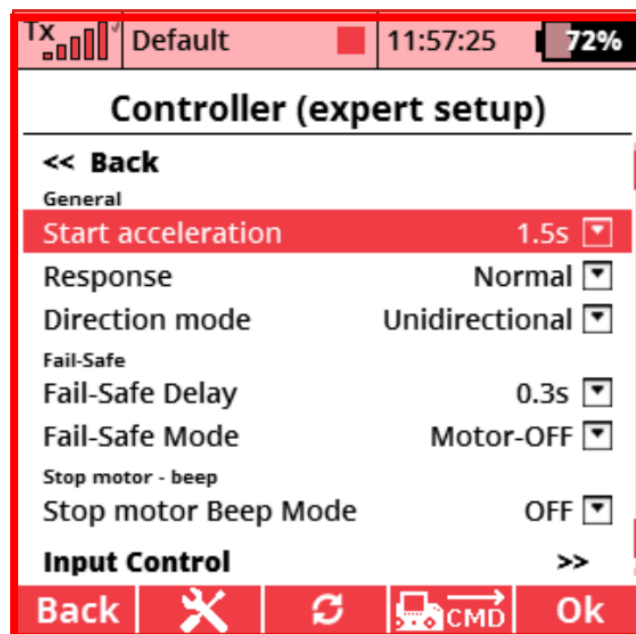

Note: for model aircraft: the larger the propeller, the longer the acceleration time must be set. Also, for a large outrunner motor, use an acceleration time of 2 seconds or more. Setting the acceleration too fast for large motors and large propellers results in large starting currents that can lead to damage to the controller.

Note: for helicopter models: the Start acceleration time can be set up to 90s, which allows for a very smooth rotor start-up. For these reasons, select a "Start Acceleration" value at least of 6s or more for helicopters.

5.2.2. Response

- the parameter describes how fast a running motor responds to throttle changes

Options without active governor function (aircraft, car and ship models):

Normal: the parameter "Response time" is the same as "Starting acceleration"

Fast: the fastest time set by the controller, usually around 0.2s

Options with active governor function (helicopter models):

Normal: the parameter "Response time" is the same as "Starting acceleration"

Fast: the fastest time set by the controller, usually around 0.2s

Manual: manual setting of the "Response time". Setting range 0.2 - 20s

5.2.3. Direction mode

- The **MEZON EVO** controller allows users to set unidirectional rotation mode (aircraft and helicopter models) or bidirectional rotation mode (vehicle, car and ship models). By the selected mode, the throttle layout is also changed. The unidirectional mode has neutral, i.e., zero motor RPM, at a minimum of the throttle. The bidirectional mode, neutral is set to the centre of the throttle range.

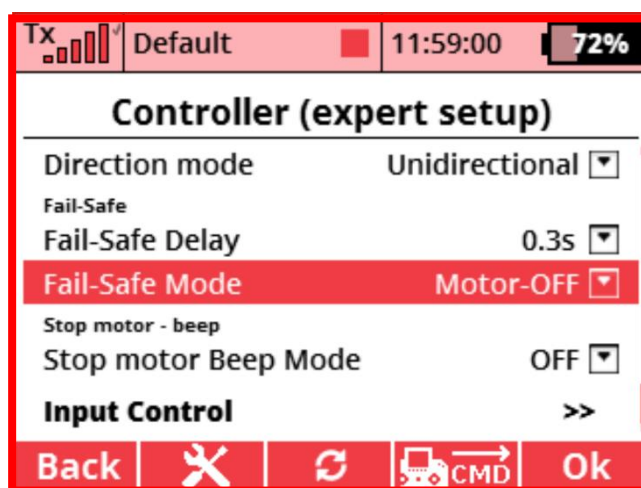

NOTE: For safety reasons, the change of rotation direction mode is activated only after the power cycle of the controller.

"Direction mode" settings:

Unidirectional mode - the motor rotates in one direction only. Zero RPM is at minimum throttle setting.

Bidirectional mode - the motor rotates in both directions. Neutral (zero motor RPM) is in the middle of the throttle range. The controller automatically sets a neutral position when connected to power. The controller announces by a single beep the correct setting. By repeatedly beeping, the controller indicates that the throttle is not within the correct limits.

Note: In the governor mode and F3A mode, the controller can only be operated in unidirectional mode.

5.2.4. Fail-Safe Delay

- The controller switches into "Fail-Safe" mode when the receiver signal is not detected correctly or the throttle cable is disconnected. The parameter specifies the time the controller will switch to Fail-Safe mode under incorrect/not present throttle. The default setting of the controller is 0.3s.

5.2.5. Fail-Safe Mode

-Setting the controller's mode of the Fail-Safe.

Motor-Off - the motor stops when the Fail-Safe function is activated. When the throttle is set to a minimum (to a neutral position in profile "Auto" or "Boat"), the controller beeps once. If the connection is restored, the controller can be controlled again with the throttle.

Motor-Hold- after activating the Fail-Safe function, the controller holds the last valid throttle. If the controller is switched to the mode and then the controller detects a correct throttle (the connection is restored), the controller immediately enters normal mode without the need to throttle back to neutral.

Fail-Safe - the controller sets the specific throttle by setting the "Fail-Safe Value" when the fail-safe function is activated. If the controller is switched to the mode and then the controller detects a correct throttle (the connection is restored), the controller immediately enters normal mode without the need to throttle back to neutral.

Note: Please check the Fail-Safe setting before the flight because it is an important safety feature and the setting is entirely the responsibility of the modeller! If not set correctly by the user, completely undesirable reactions can occur, such as the motor spinning up to full RPM when entering the Fail-Safe state or the flight of an uncontrollable model with the motor running.

5.2.6. Stop motor beep mode

- Acoustic signalling during the motor off warns the modeler that the controller is ready to run.

OFF: sound signalling is not active

ON (5s): beep every 5s

ON (20s): beep every 20s

Note: when the brake is activated, the motor during signalling is not braked

5.2.7. Input control

The structure of the menu depends on whether the controller is operated in governor mode (helicopter model) or other modes. The "**EX Bus Control**" parameter is used for all modes of the controller (governor, ...). In the menu you can set the source of the throttle (servo input or **EX Bus** serial communication) and how the controller operates with the throttle.

The menu is divided into three groups of settings:

- "EX Bus control"
- the mode without the governor
- mode with the governor

5.2.8. EX Bus control

The **EX Bus** is a serial communication in which the **Duplex** system transmits not only telemetry data but also channels for control of the controller, servos, ... (e.g. see 2.6). Therefore, EX Bus can be used to control the controller without any additional connection between the receiver and controller - just one cable EX Bus (see chapter 2).

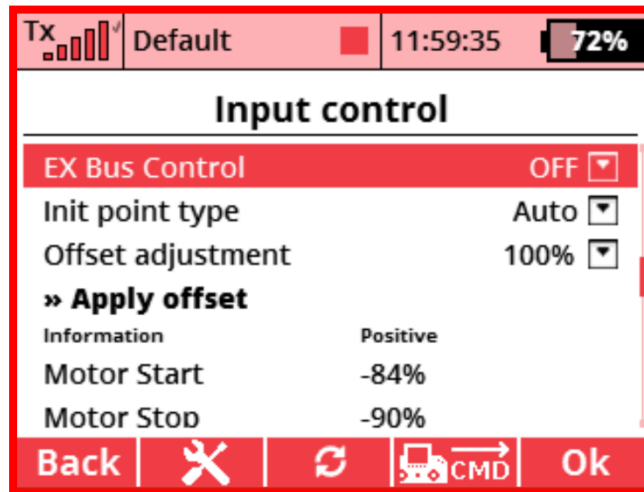

EX Bus control:

"Off" - the controller receives information about the throttle by a black JR connector via servo signal from the receiver (e.g. 2.6). When **EX Bus/EX telemetry** communication between the receiver and the controller is connected by a red JR connector, only telemetry data is transmitted via this connecting (e.g. 2.1, 2.5).

"On-Auto"- EX Bus communication is activated for controlling. The controller automatically detects the throttle channel from the **EX Bus**. This option supports only the **JETI Duplex** system and connection is specified, e.g., in chapters 2.1, and 2.5.

Setup description:

- Set **"EX Bus Control"** to **"ON-Auto"**
- select the **"Edit"** item, it starts the automatic detection process
- confirm the process and move the desired throttle control on the transmitter
- if the autodetection is correct, the channel number and its value is shown next to the **"Edit"**.

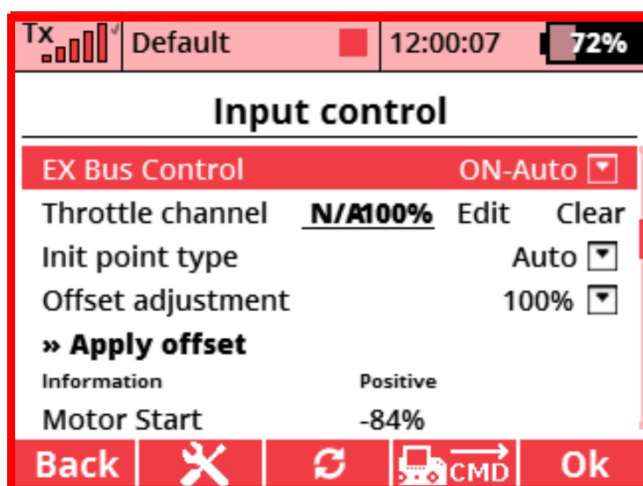

- when the throttle is set the motor is started and it is controlled by the assigned throttle control

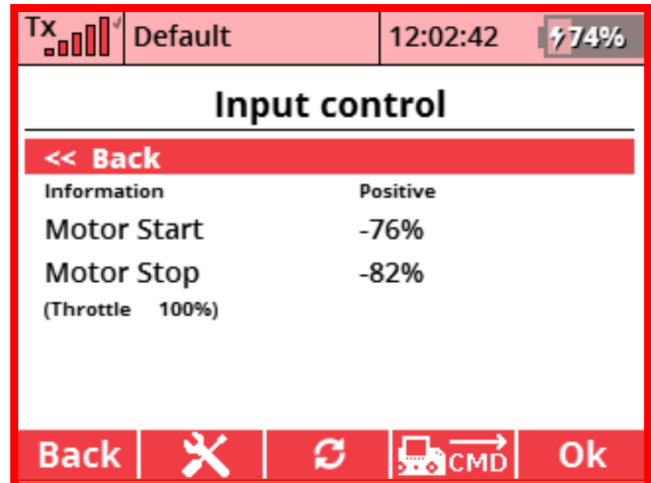
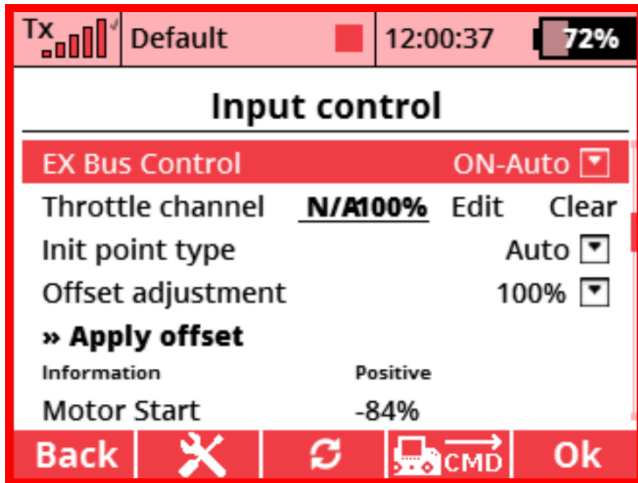

"On-Manual" - manually assign a channel from EX Bus that controls the controller. By activating this option is shown a list of available channels for manual selection and assignment.

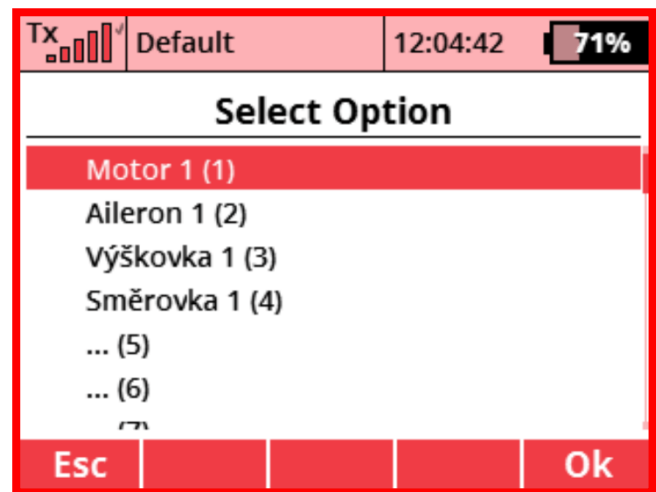
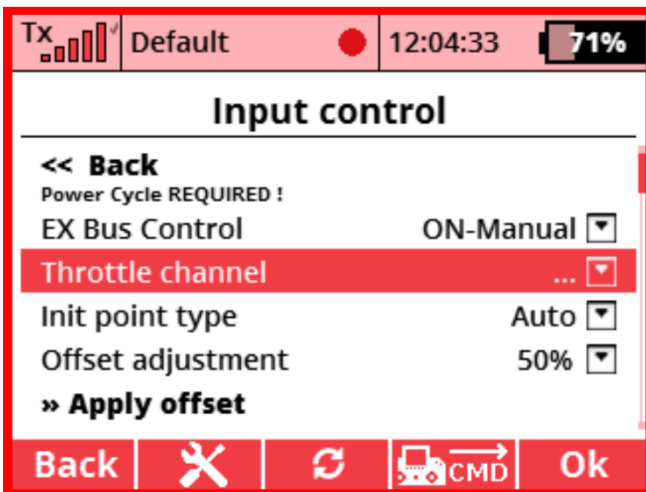

Menu "Input control" – governor disable

- setting the threshold of the input control for starting, stopping, and braking the motor. If the controller operates in bidirectional mode, the menu is extended with an additional column of parameters for the "negative direction" of motor rotation.

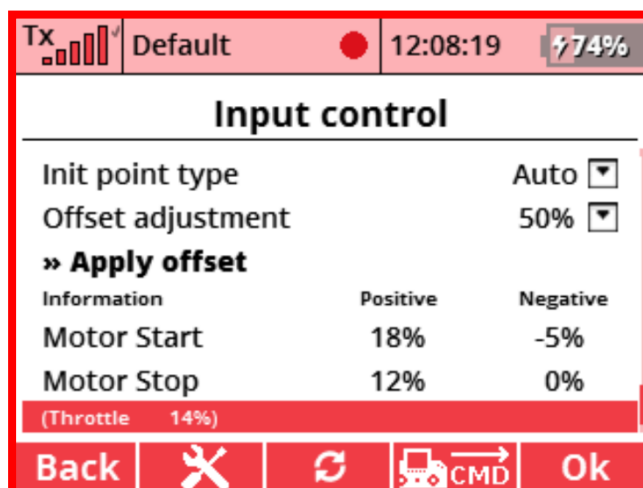

5.2.9. Init point type

- the setting for outer limits of the throttle for stop and maximum motor RPM.

Auto: the throttle at the moment the controller is switched on is taken as the value for a stop motor.

Fixed: manual setting of the values for the stop motor "**Init point**" and maximum RPM "**End point**".

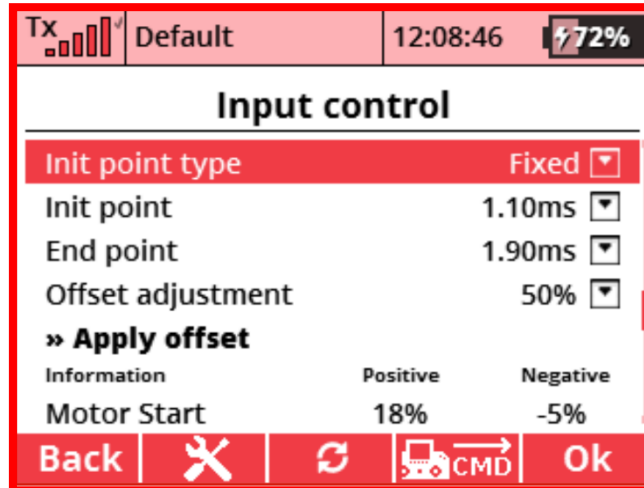

Note: the "**Init point**" value has to be set on a higher value than the throttle at the moment turn on. If the condition is not true, the motor does not start.

Similarly, the "**End Point**" value has to be set to a lower value than the throttle at maximum. If the condition is not true, the motor does not reach maximum RPM.

5.2.10. Offset adjustment

The parameter "Offset adjustment" changes the threshold for all actions i.e. "**Motor start**", "**Motor stop**" and "**Brake activation**".

The lower the value of the "Offset adjustment" is set, the sooner the motor starts on the throttle lever. The range between the motor start and stop or brake activation points is also reduced.

Range of adjustable values: 50 -100%

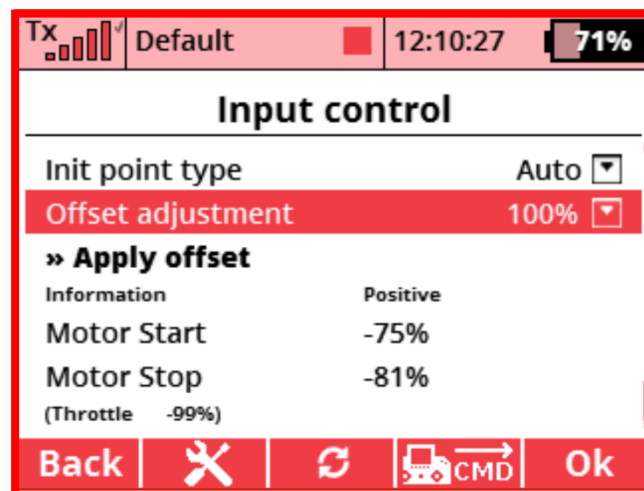

To apply the parameter "Offset adjustment", either switch the controller off/on or confirm the "**Apply offset**".

Menu „Input control“ – governor enable

The menu is available only if the governor function is enabled. Input control is scaled to setpoint RPM, the threshold for start/stop of motor, and the range for autorotation.

Note: for safety reasons, changes to the settings are applied after confirmation of the "Apply scaling" at the end of this menu or after the power cycle of the controller.

In the governor mode, the input control has to be set to a fixed minimum ("Initial point") and maximum throttle ("End point"). Automatically setting both parameters is not possible.

The governor function needs to know the exact lowest and highest value of the throttle for correct scaling RPM.

The screenshot displays the 'Input control scaling' menu. At the top, it shows 'Tx' signal strength, 'Default' mode, the time '12:12:34', and a battery level of '71%'. The menu items are as follows:

- << Back
- EX Bus Control OFF
- RPMmax (gear out) 8000 rpm
- Initial point 1.10 ms
- End point 1.90 ms
- Start point 20 %
- Offset adjustment 100%
- Rotor Gear 1.0:1
- RPMmin (gear out) 1300 rpm
- Autorot. threshold 1.165 ms
- Motor Stop 1.230 ms
- Motor Start 1.260 ms

A graph below the settings shows RPM on the y-axis and THROTTLE on the x-axis. The y-axis has 'min' and 'max' labels. The x-axis has 'min', 'autorot', and 'max' labels. A green line represents the throttle curve, with 'start' and 'stop' points marked. The bottom of the screen features a red bar with the text '» Apply scaling' and a navigation bar with icons for 'Back', a wrench, a refresh, 'CMD', and 'Ok'.

Definition and description of menu items:

5.2.11. RPMmax (gear out)

- set the rotor RPM recommended by the helicopter manufacturer. The value corresponds to the desired maximum motor RPM for full throttle (see chart).

Tip: a faster way for setting the values is to use a multiplier. When setting the values, by pressing the "MENU" button can be selected multiplier x1, x10, x100 or x1000.

5.2.12. Initial point

- setting the minimum value of the control pulse in ms. This value corresponds to zero motor RPM.

5.2.13. End point

- setting the max. value of the control pulse in ms. This value corresponds to the maximum desired motor RPM.

5.2.14. Start point

- percent value from the range of input control for starting motor.

The autorotation threshold is located in the middle of the range between the "Initial point" and the "**Motor Stop**" point. The "**Autorot. threshold**" is active when the autorotation function is used. For more information, see the description of the autorotation.

Note: the meaning of the described parameters is clearly shown in the graph above.

Offset adjustment

- the setting of the hysteresis (**deadband**) between the points "**Motor Start**" and "**Motor Stop**". The parameter changes the range between the motor start and motor stop points - it means deadband between the start and the stop of the motor.

5.2.15. Gear ratio

- gear ratio between the motor and the main rotor of the helicopter. Correct setting of the gear ratio is essential for the correct operation of the controller, the RPM ratio must correspond to reality!

Note: in the governor mode the controller always works with the RPM directly at the output of the gearbox, i.e., at the rotor of the helicopter. If you select the correct gear ratio and the setpoint RPM on the main rotor, the controller will set the appropriate motor RPM.

RPMmin (gear out)

- minimal rotor RPM. This value is automatically estimated by the controller from the range defined by Offset adjustment and Init point. The parameter indicates the minimum RPM that can be achieved for a given setting.

Autorot. thershold - the parameter set by the controller for the autorotation. For more information see the description of the autorotation function.

Motor stop - the value of the control pulse in ms that the motor stops.

Motor start - the value of the control pulse in ms that the motor starts.

5.3. Motor

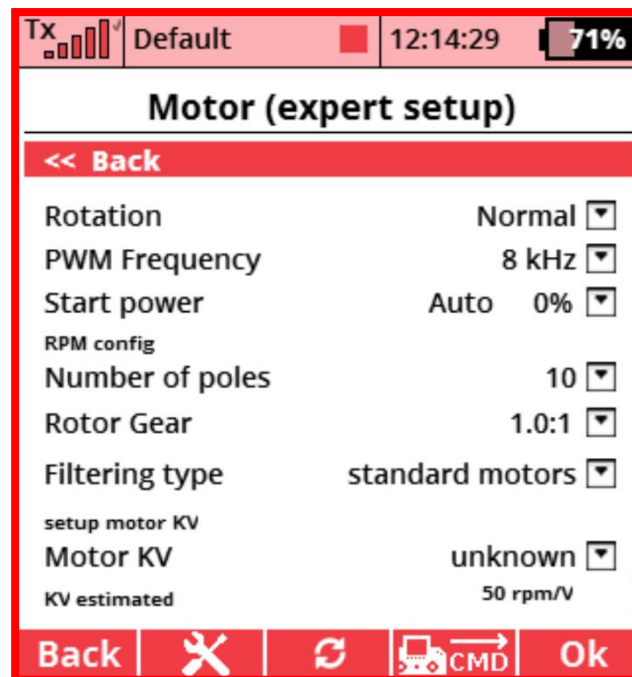

5.3.1. Rotation

- reverse the direction of motor rotation

5.3.2. PWM frequency

- value of modulation frequency. 8kHz is suitable for most application and it is also recommended value if motor producer do not specify anything else.

Possible values: 8 – 16 – 32 kHz

5.3.3. Start power

- defines initial power for motor start from zero revolution. Start power is determined automatically. It's possible tune Motor start behaviour with this parameter regards the motor and load type. For lower values motor start is smoother but start can be unreliable. For big motors and load with high inertia increase the value as necessary.

Adjustable range: -50% to +50%.

5.3.4. Timing

- defines motor timing

Setup according to motor producer recommendation. If the value is not available use setting in accordance with common recommendation listed below:

2 poles motor ... 0 - 5°

4 poles motor ... 5 - 10°

6 poles motor ... 10 - 20°

8 and more poles motor ... 20 - 25°

Note: This parameter is not available in Governor mode. Timing is controlled automatically in this mode.

5.3.5. Number of poles

- entering the correct number of motor poles is important for correct telemetry value of actual RPM and for correct governor function. Governor will not be able to control different RPM value if number of poles is set up incorrectly. Real motor RPM will not correspond with displayed value. If you do not have information about number of poles, please see chapter **“Solving problems – Setup with unknown motor”** at the end of manual.

Adjustable range: 2 – 48 poles

5.3.6. Rotor Gear

- defines gearbox ratio between motor and load (propeller or rotor blades). Entering the true value is important for correct telemetry value of actual RPM. Controller always works with load RPM in governor mode, because producer of helicopter recommends demand RPM value of rotor blades. If the true value of gearbox ratio and demanded RPM are entered controller automatically controls appropriate RPM of the motor.

Adjustable range: 1:1 až 20:1 (modifiable by a tenths)

5.3.7. Filtering type

- type of filtering BEMF signal from motor (BEMF control commutation sequence)

The most of BLDC motors for RC models are in high-speed design. Filtering type for **“standard motors”** is recommended for these motors.

Occurrence of wrong commutation is possible for motor with very high motor poles (cca > 28p) and very low KV (< cca 215 rpm/V). For example: motors Q60, Q80 and above - HACKER, XPWR 35/40/60, Dualsky GA6000-8000 or Kontronik Pyro 650. Set up **„mot. with very low KV”** for these cases.

Possible choices: standard motors / mot. with very low KV

5.3.8. motor KV (rpm/V)

- this parameter is available only in governor mode. True value of KV is important for correct governor function. Enter the value according to motor producer datasheet. If you do not have information about motor KV is possible identify it by easy measurement - please see chapter **“Solving problems – Setup with unknown motor”** at the end of manual.

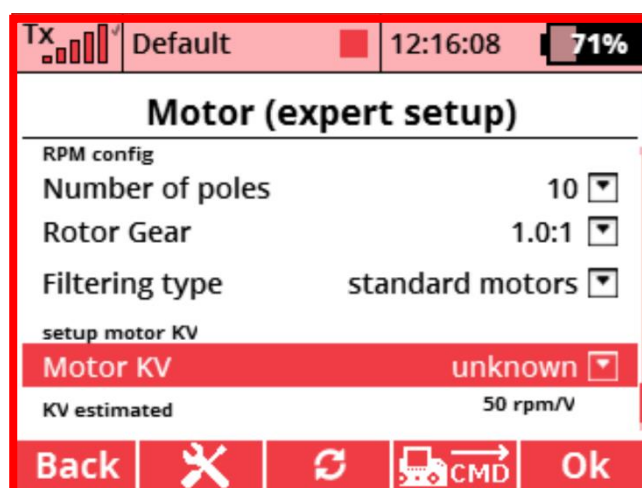
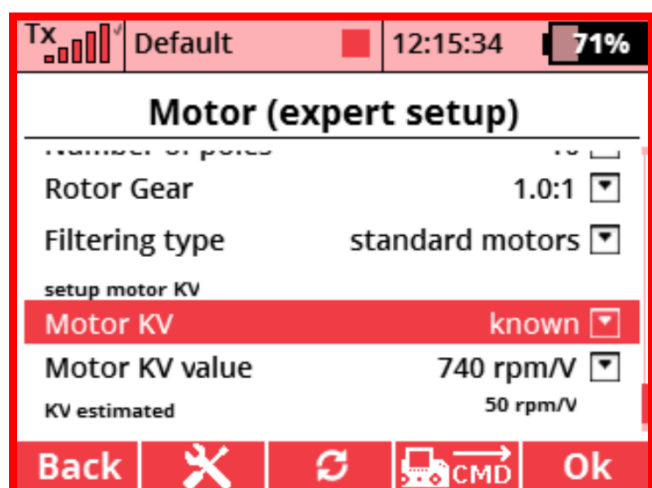

It's also possible to choose **“Motor KV” – “unknown”**. The controller tries to identify and calc the KV value during motor run. This estimated value is displayed in KV estimated row.

5.4. Brake

– this menu is available only if governor is deactivated

MEZON EVO controllers have four fix predefined brake profiles: „**OFF, Soft, Medium and Hard**“. These basic choices are extended by „**Manual**“ and „**Proportional**“ profiles. Brake values are defined by user in manual profile. Brake strength depend on throttle stick position in proportional profile.

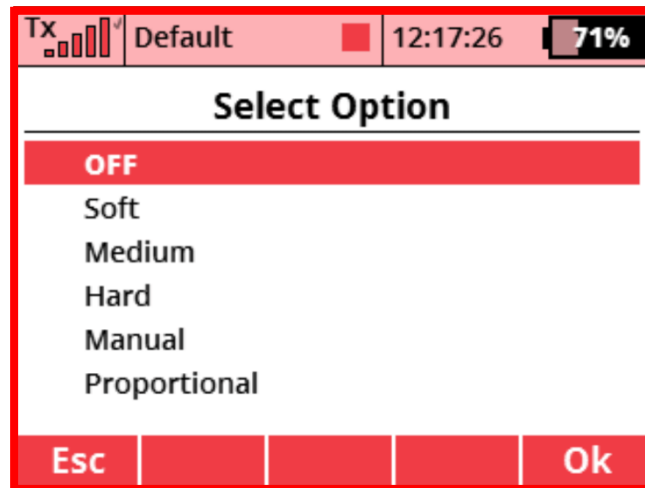

OFF – brake function is deactivated

Soft – fixed profile with these parameters:

Begin power	30%
End power	100%
Dead time	0,5s
Speed	1,5s

- braking start with 0,5s delay after brake activation; initial brake strength is 30% and finish brake strength is 100%; brake strength is increasing from initial to finish value in 1,5s.

Medium – fixed profile with these parameters:

Begin power	50%
End power	100%
Dead time	0,5s
Speed	1s

- braking start with 0,5s delay after brake activation; initial brake strength is 50% and finish brake strength is 100%; brake strength is increasing from initial to finish value in 1s.

Hard – fixed profile with these parameters:

Begin power	70%
End power	100%
Dead time	0,5s
Speed	0,5s

- braking start with 0,5s delay after brake activation; initial brake strength is 70% and finish brake strength is 100%; brake strength is increasing from initial to finish value in 0,5s.

Manual – brake values defined by user

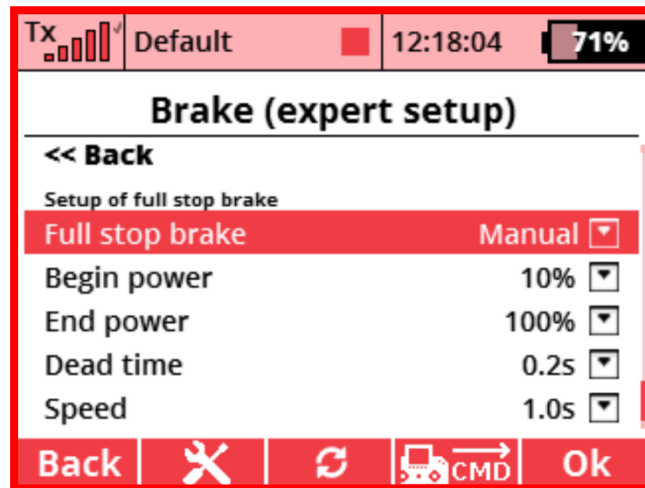

All brake parameters are defined by user within below listed range.

- Begin power** 0 - 100%
- End power** 0 - 100%
- Dead time** 0 - 5s
- Speed** 0,1 – 10s

Proportional – in this profile brake strength depend on throttle stick position. Therefore, it's possible control not only motor power but also brake strength with the throttle stick.

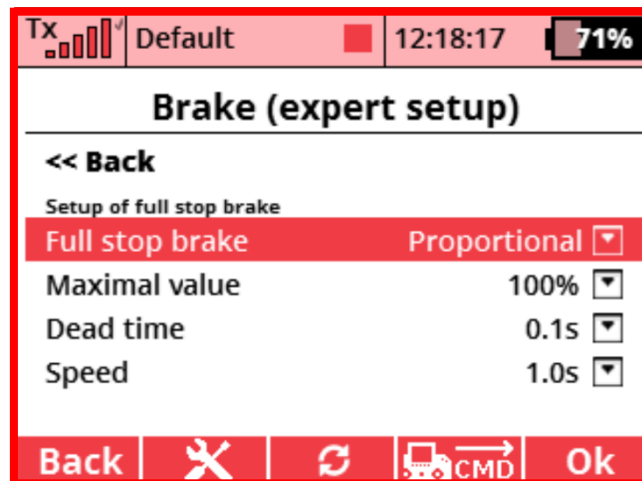

- Maximal value** – maximum brake strength (10 – 100%)
- Dead time** – delay between motor stop and brake activation (0 – 5s.)
- Speed** – time to reach maximum brake strength since brake activation (0.1 – 10s.)

5.5. Limits & Protections

- In this parameter group user can define limits values of voltage, current, temperature and capacity together with setup the number of battery cells. It's also possible to setup controller behaviour if limit values are reached.

WARNING – be careful about the setting parameters in this Limits & Protections group. Wrong parameterization can cause controller or accumulator damage, eventually decrease their lifetime or power!

WARNING – automatic number of battery cells detection works correctly only if full charged accumulator is connected to the controller!

5.5.1. Accumulator type

- possible choices:

„Ni-XX“ - nickel-based batteries (NiCd, NiMh)

„Li-XX“ – lithium-based batteries (Li-Po, Li-Ion)

„Direct“ – cut-off voltage defined by user

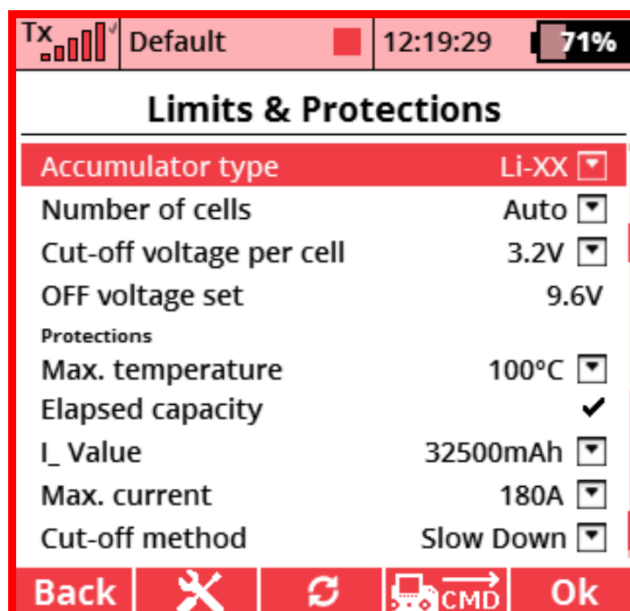

5.5.2. Cut-off voltage per cell

– user defines minimal voltage value per one accumulator`s cell according to range listed below:

„Ni-XX“ 0,5 – 1V per one cell

„Li-XX“ 2 – 3,6V per one cell

„Direct“ 5 – 46V per whole accumulator

OFF voltage set – display automatically calculated value according to parameterization mentioned above and detected or manually defined number of cells.

5.5.3. Max. temperature

- controller temperature which initiates the controller`s protection

Adjustable range: 50 - 125 °C.

WARNING – risk of controller damage for setting above 100°C. The option to set higher temperature is intended for experienced user and competition purposes.

5.5.4. Elapsed capacity

- value for maximum capacity taken from accumulator. Reach elapsed capacity initiates accumulator protection according to the setting in cut-off method parameter.

Adjustable range: 100 – 32500 mAh.

5.5.5. Max. current

– battery current which initiate controller`s protection

Adjustable range: 20-180A

Recommended value: 180A

Note: Reaching the max. battery current will cause decreasing motor power and motor RPM. The controller limits the motor power to prevent exceed maximum battery current. If user set up this value too low motor can loose power and speed due the dynamic demands of load (propeller and motor inertia).

5.5.6. Cut-off method

– selection of the controller`s reaction to reaching minimum battery voltage, reaching elapsed capacity or reaching maximum temperature.

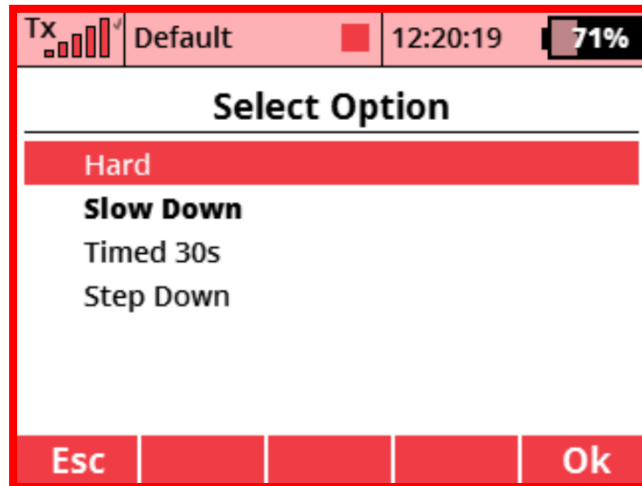

Possible choices:

- „**Hard**“ – motor stops immediately if some of the above mentioned limits are reached for 2s.
- „**Slow down**“ – available motor power is continuously decreasing during 30s. from actual RPM until motor stops
- „**Timed 30s**“ – available motor power is continuously decreasing during 30s. from actual RPM until motor stops. Controller monitors limits (temperature, capacity, voltage) during this decreasing process and if the value recovers back into allowed range the power decreasing is interrupted and continues to increase back to the normal operation.
- „**Step down**“ – if some of above mentioned limit is reached (temperature, capacity, voltage) then available power of motor is immediately decreased by cca 20%. The pilot is able to notice power step decrease by RC model behaviour. Decreased power is available for next cca 15s and safety landing is possible. After that time is available power continuously decreasing until motor stops. This choice can be useful for drones and helicopters sometimes.

5.6. Governor

The main task of the governor (constant speed controller) is to maintain the required motor speed regardless of load changes and other influences. In accordance to general theory the governor can be set to “hard” (very fast response) or “soft” (slow response). Governor reaction to load changes is fast and intense with “hard” setting. RPM are precisely maintained at the required speed and quick change of load cause only short-term drop of RPM. The disadvantage of “hard” setting is risk of governor instability and oscillations because even a small change of load causes intense governor reaction. On the other hand, “soft” governor setting doesn`t have so big risk of instability. Governor reaction on load changes are more slower and not so intense, but of course, the RPM deviation can be bigger and with bigger short-term drop of RPM. In practice, it is necessary to adjust the governor into suitable compromise between „hard“ and „soft“ setting.

Note: menu for governor setting is available only if helicopter is chosen as vehicle type

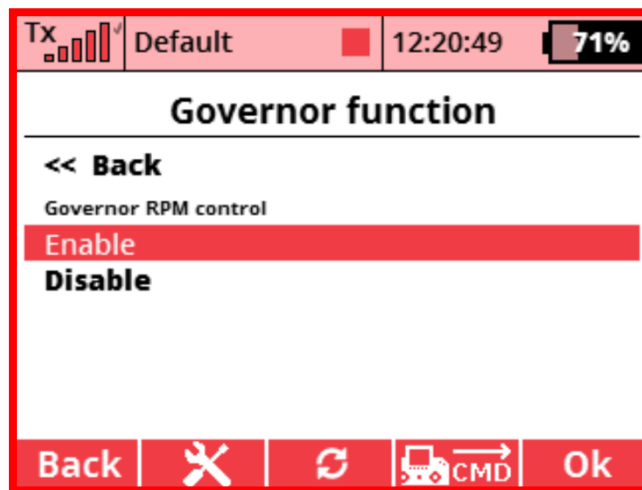

If governor is enabled then the below listed parameters and functions are available. These parameters are divided into two groups:

- „User“- easy and user friendly menu for governor setting
- „Expert“- access to all parameters of governor setting

5.6.1. User – recommended basic setup of governor

- this mode is prepared for all user regardless their experience
- we recommend use this mode for governor setting!
- MEZON EVO controller automatically calculate and set optimal governor values in this mode
- automatically calculated the initial governor setting is a little “soft” without instability risk. This initial setting is marked as „Auto +0%“
- by changing only one parameter in the range „Auto-30%“ to „Auto+120%“ you can easily adjust governor behaviour between “soft” and “hard” setting



Note: if increased value of „Auto+xx“ cause rpm oscillation, this means the governor setting is too “hard” and the governor has reached its instability limit. It’s necessary to decrease the value of „Auto+xx“ back to a stable value.

5.6.2. Expert – user defines governor control constants manually in this mode

It is not necessary use expert mode for the most user. User requirements are fulfilled with the automatic user mode mentioned above. Expert mode is focused for solving atypical designs and special requirements. Professional knowledge is necessary for expert mode and the user is responsible if using this mode. There is a big risk of instability and motor oscillation with inappropriate settings!

Direct setting of governor control constants is possible in this mode. Gain „ kP “ and time integration constant „ kTi “ of speed controller and „ Ri compensation“ for feed forward control loop. If „Expert“ mode is activated then initial values of „ kP “, „ kTi “ and „ Ri “ are set in accordance with internal automatic experience algorithm used in user mode. We recommend take these values into consideration as initial optimal mean values. If necessary, continue in fine tuning from these values.

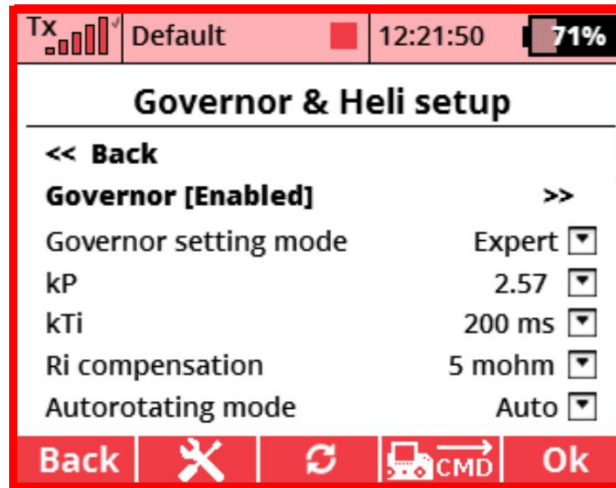

General description of „ kP “, „ kTi “ and „ Ri “ parameters:

5.6.2.1. kP

- gain of speed controller. Defines immediately the intense of controller reaction on RPM changes causes by load changes. The bigger value you setup, the faster and more intense will be the speed controller reaction. The big values of kP causes instability and oscillation. On the other hand, the low values cause big differences between demanded and actual RPM and the governor doesn't fulfil the main task – speed control.

5.6.2.2. kTi

- time integration constant. Integration part of speed controller ensures elimination of deviation between demanded and actual RPM = RPM error. The low value of kTi cause quick elimination of RPM error deviation, but with risk of instability. The higher value of kTi increases system stability, but also inertia of system is increased and deviation elimination is delayed.

Note: If $kTi = 0ms$, then integration part of speed controller is OFF. There always exists RPM error in this mode. Speed controllers with gain only always have some speed error = difference between required and actual RPM.

5.6.2.3. Ri compensation

- you can setup Ri value in accordance to motor producer datasheet. Controller use this value for feed forward control loop and compensate drop voltage on Ri . This can increase control quality, system stability and reduce the response time.

5.6.2.4. Autorotating mode

There are two different modes of motor start for helicopters. Soft start for smooth initial start of rotor blades when helicopter is on the ground and rapid motor start during autorotation, and often motor restart during flight. Rapid motor start during autorotation is helpful, because pilot wants to avoid helicopter damage, but there is a risk of bigger stress on mechanical parts. On the other hand, smooth soft start of rotor blades without mechanical stress is required when helicopter starts on the ground. Controller behaviour for described starts can be user influence by setting the parameter „Autorotating mode“.

Possible choices:

- Autorotating mode OFF**
- Autorotating mode Auto**
- Autorotating mode Range**
- Autorotating mode Range + Time**

Autorotating mode – OFF

- Motor always starts with initial smooth acceleration. You can set this acceleration time in parameter „Start acceleration“.

Autorotating mode - Auto

- The controller assess if motor turns or not when start command from throttle position is received.
 - If motor doesn't turn then controller starts motor according to acceleration in parameter „Start acceleration“.
 - If motor turns then controller starts motor according to rapid acceleration in parameter „Response“.

Note: Helicopter vehicles often use freewheel mechanical connection of rotor blades. This can cause that motor RPM evaluation doesn't work properly. Rotor blades turn, but motor turn slowly or not turn. Therefore, there are other choices below which can be more helpful in this situation.

Autorotating mode - Range

- If throttle position decreases into autorotation range (between „stop“ and „autorot“ level – see picture below) then motor will be off. But return throttle position back above „start“ level cause immediately start of motor according to rapid acceleration in parameter „Response“.
 - If throttle position decreases under „autorot“ level then new motor start will be according to smooth acceleration in parameter „Start acceleration“.

Autorotating mode – Range + Time

- Controller's behaviour is the same as previous mode "Range", but time condition is taken into consideration also.
 - If throttle position decreases into autorotation range, controller begins to monitor time, how long is throttle in this range. This time is compared with time in parameter "Autorot. expiration time".
 - If time is expired then new motor start will be according to smooth acceleration in parameter "Start acceleration" regardless the throttle position.
 - If throttle position remain in autorotation range and controller receive demand for new start before time expiration then motor starts immediately according to rapid acceleration in parameter "Response".

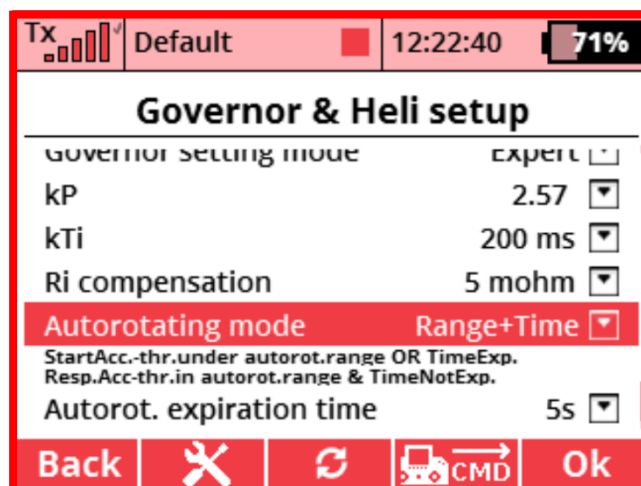

5.7. F3A mode

Note: this menu is only visible if "F3A Plane" is selected in the "Model type" menu.

The **MEZON EVO** controllers are equipped with a mode for aerobatic aircraft models of the F3A category. In this mode the brake intensity depends on the throttle lever position. This actively controls and stabilizes the speed of the model in descending turns. This new feature could be compared to cruise control, controlled by throttle position.

In this mode, the energy recovery function is automatically active. When the model is actively braking in descending manoeuvres, part of the energy is returned to the battery.



Flying restart transition time

- the only adjustable parameter in "F3A" mode is " **Flying restart transition time** "
 - this value defines the transition time between the current engine speed and the desired speed according to the throttle position when the control is moved while the motor is spinning.
- This situation is typical when the throttle lever is moved to minimum during descending flight of the model, but the engine is still spinning the propeller in the airstream. In this situation, when the throttle is increased, the controller will control the engine acceleration according to the value set in the " Flying restart transition time " parameter.
- The adjustable range is 0.2 - 12s.

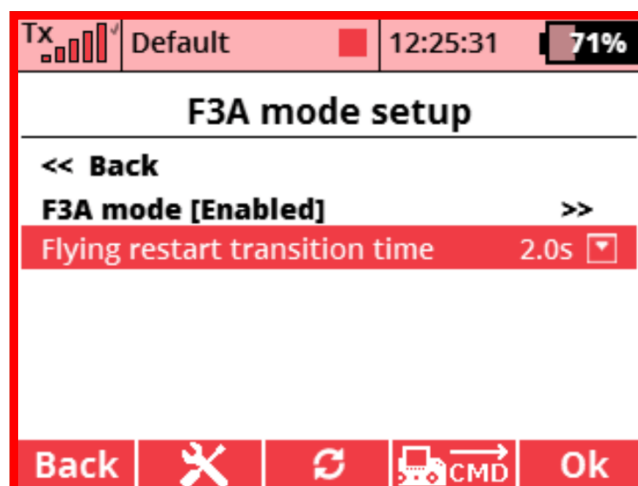

5.8. BEC

- this menu is available only for controllers equipped with **BEC** circuits. Therefore, it is not available for the **MEZON EVO 85 OPTO** controller from the **MEZON EVO** series.

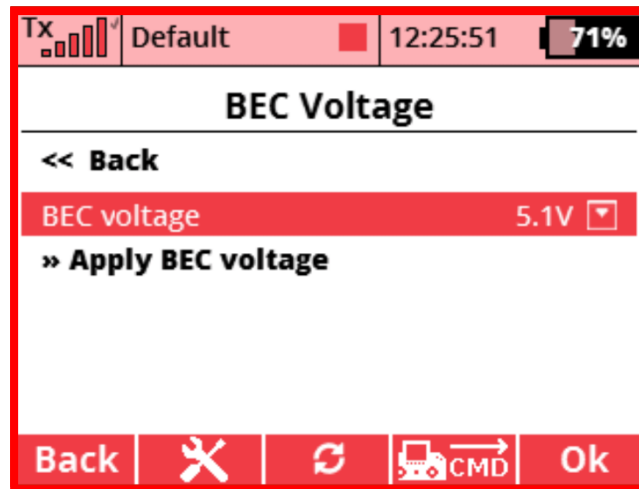

BEC = voltage stabilization circuit for the on-board power supply, in the case of the **MEZON EVO** series it is an adjustable power supply with the following features:

- stabilized output voltage adjustable from 5 - 8.4V in 0.1V steps
- thermal protection of the power supply with gradual power limitation
- integrated output short circuit protection
- maximum peak current 30A/1s
- average current 15A

- the temperature of the **BEC** switching power supply should not exceed 100°C. Therefore, during installation, ensure there will be sufficient cooling of the controller with air flow
- at temperatures around 120°C, internal protections are activated and the output voltage of the **BEC** is reduced to protect the power supply from destruction. The **BEC** output voltage reduction can be identified by the slowing down of the servos while maintaining the controllability of the model
- for these reasons we recommend to create an alarm in the **JETI Duplex** transmitter with a **BEC** high temperature warning and set it to 100°C

6. Telemetry

- MEZON EVO series controllers have integrated full support for **Duplex EX** telemetry data transmission
- the system displays telemetry data in real time and stores it in the transmitter's memory for later analysis
- each value can be enabled or disabled for archiving in the transmitter memory
- disabling unnecessary items reduces the amount of data transmitted and increases the system's clarity

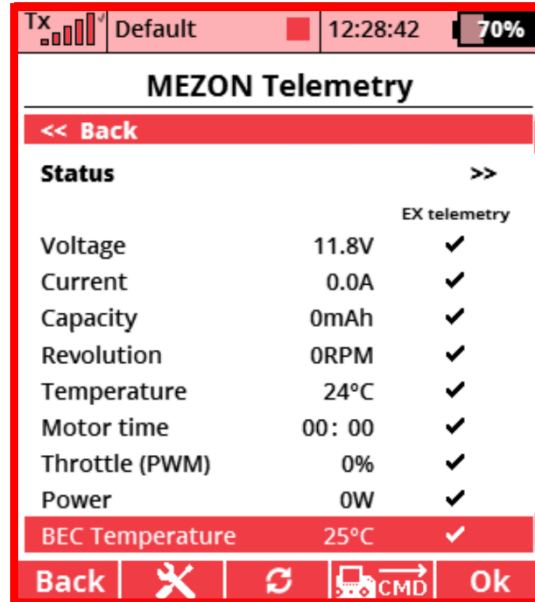

Status

- in the "Status" menu any errors occurring during operation of the controller are noted.
- the data is used to diagnose and eliminate the causes

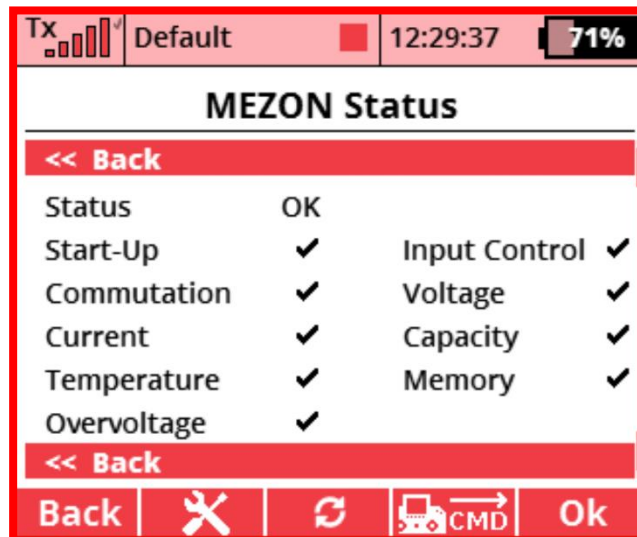

Description of possible causes of error events:

Start-up - engine start-up sequence is longer than 6s

Commutation - the controller is not able to correctly reading the position of the motor rotor

Current - the current is greater than the set limit (see "Limits->Maximum current")

Temperature - the temperature is greater than the set limit (see "Limits->Maximum temperature")

Control Input - Error reading throttle position information

Voltage - the voltage is less than the set cut-off voltage (see "Limitations->Set cut-off voltage")

Capacity - the capacity taken from the accumulator is greater than the set limit (see "Limits->Taken capacity")

Memory - there was an error retrieving the controller configuration and the controller has restored its factory settings

Overvoltage – while the engine was running, there was an overvoltage on the engine, which caused it to shut down. This condition can only occur during braking of large active loads and if the power supply or battery is unable to absorb the energy generated by the motor.

7. Telemetry Min/Max

- This window displays the maximum and minimum values of the following parameters since they were last cleared

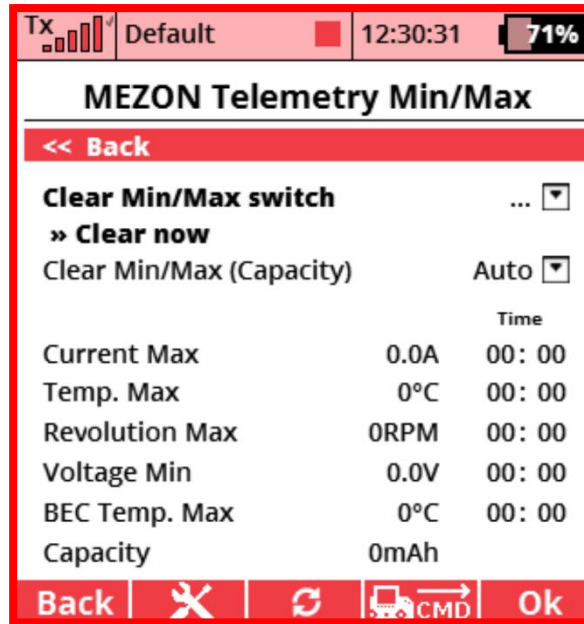

Description of parameters:

Clear Min/Max switch – selects a switch on the transmitter or a transmitter function that resets the stored values and starts a new recording

Clear now – confirming this option immediately resets the stored values and starts a new recording

Clear Min/Max (Capacity) – possible options:

„**Auto**“ - after 10s after the first motor spin, the previous statistics are cleared and new data starts to be recorded

„**Manual**“ – the stored values are deleted and a new record is started by a user command (see "Clear Min/Max switch")

8. Reset to factory defaults

- activating this parameter and confirming the option will set the controller to the default (factory) setting

9. Troubleshooting

9.1. Firmware update

- updating the firmware of MEZON EVO controllers is carried out using the same procedure as in the chapter "**Setting up MEZON EVO Controllers by computer**".

- open the "**Tools/Device Updater**" dialog

- connect the three-wire cable of the MEZON EVO controller with the red connector to the **USB adapter**.

Note: If the controller is connected to USB, the three-wire cable with the black connector must not be plugged in.

- connect the batteries to the controller

- the program will automatically identify the connected device, offer an update history and show the appropriate firmware version
- select the desired firmware version and confirm with "Update"

9.2. Setting the controller to run with an unknown motor

For a smooth and correct operation of the controller with a governor, it is important to specify the correct number of motor poles and KV constant (rpm/V). These values are necessary to calculate the motor revolutions. If you are working with a known motor, always start with the correct values given by the motor manufacturer.

If these values cannot be found, follow the instructions below:

Procedure for determining the number of motor poles

- switch off the active governor mode.
- start the motor and use a revolution-counter to measure the actual motor revolutions.
- on the connected Jetibox or JETI Duplex transmitter display, compare the revolutions
- if the revolutions do not match, change the motor pole count value until the two readings match

Procedure to determine the Kv of the motor

Option 1

- Turn off governor mode
- make sure you have the correct pole count see the following. "Procedure for determining the number of motor poles"
- remove the propeller or any other motor load, the motor must not be loaded
- spin the motor at 100% full throttle and read the motor revolutions from the connected Jetibox or transmitter display
- then determine the Kv value using the equation:

$$Kv \left[\frac{rpm}{V} \right] = \frac{Nmax[rpm] * i}{Ubat[V]}$$

Where is: **Kv** ... voltage constant of the motor in [rpm/V]
 Nmax ... Maximum revolutions reached at full throttle [rpm]
 i ... gear ratio
 Ubat ... battery supply voltage [V]

Specific example:

you supply the motor at no load from a 24V battery
 the motor is without gearbox (1:1 ratio)
 the maximum measured motor revolutions were 18 575 rpm
 the voltage constant is therefore:

$$Kv \left[\frac{rpm}{V} \right] = \frac{18575 * 1}{24} = 773,9 \left[\frac{rpm}{V} \right]$$

- After rounding to the nearest ten, you enter Kv = 770 into the controller.

Option 2

Turn on the governor mode and make sure you have the correct number of poles set see. "**Procedure for determining the number of motor poles**"

Remove the rotor blades, propeller, disconnect any motor load

spin the motor up to about 50% throttle

in the "**Actual values**" display menu or on the JETI Duplex transmitter display, you will find the KV calculated item, the controller calculates the real **Kv** of the motor during the run and displays it in this item

leave the controller on until the motor Kv value is stable and enter this value into the controller as the "Motor KV" value

9.3. The motor is unable to reach the required revolutions when the governor is active

- Make sure that the motor pole count and Kv value is correctly entered see. "**Procedure for determining the number of motor poles**" Procedure to determine the Kv of the motor "
- the model drive (gear ratios, motor selection, power supply, etc.) must be selected so that the operating revolutions of the motor are at least approx. 20% below the maximum achievable motor revolutions, including consideration of the voltage drop on the batteries
- a margin of 20% is required to ensure that the controller is able to cover load changes and battery voltage drop while maintaining constant revolutions

Example:

A helicopter has a gear ratio (i) between the rotor blades and the motor of 1:8. The manufacturer of the helicopter model requires a rotor blade speed (**Nrot**) 1500 rpm. In this case the motor will need to be operated at RPM:

$$N_{mot} = N_{rot} * i = 1500 * 8 = 12\ 000\ rpm$$

the model will be powered by a 6S LiPo battery, that is, the expected supply voltage range:

$$\text{fully charged battery (e.g. 4V/cell): } 6 * 4 = 24V$$

$$\text{discharged batteries (end of flight) (e.g. 3V/cell): } 6 * 3 = 18V$$

in the model is a motor with Kv = 530

- the end of flight revolutions will be $18 * 530 =$ approx. 9540 rpm without load
- in this configuration the motor is not able to reach the rotor revolutions required by the model manufacturer
- the choice of such a motor is inadequate

in the model is a motor with Kv = 670

- the end of flight revolutions will be $18 * 670 = 12060$ rpm without load
- in this configuration the motor reaches the revolutions required by the model manufacturer without load, but the controller has no margin to compensate for the motor load
- the choice of such a motor is therefore also inadequate

in the model is a motor with Kv = 880

- the end-of-flight revolutions will be $18 * 880 = 15860$ rpm without load
- in this configuration the motor has a margin of about 25% to compensate for the load
- the choice of such a motor is **adequate**.

Note: the amount of margin and current PWM usage can also be easily checked using telemetry directly on the JETI Duplex transmitter display, or on the Jetibox (the indication in the lower left corner of the main screen). If the PWM value reaches 100% at full speed, the controller is fully opened and the margin is therefore 0%.

Note: the above calculations are given as an illustrative example. In addition, the calculation of the design of a suitable motor drive should also include consideration of the voltage drop across the internal resistance of the motor (R_i), losses in the power cables and take into account the flying style affecting the load and current consumption from the batteries. Always follow the model manufacturer's recommendations.

9.4. Motor beeps and cannot start

- The control input pulse value has not dropped below the initialization level or is not within the valid expected range. For bidirectional mode the valid initialization level is in the range 1.3-1.6ms, for unidirectional 0.75-1.6ms
 - Check the reasons why the input pulse is not in the valid range. These are usually throttle position, trim position, active mix, governor setting or throttle lock.
-

10. Attachments

10.1. Table of preset values of individual modes

Note: - fields marked in yellow are set to different values from the factory default

- "Plane" mode is the default (factory) setting of the controller. After resetting the controller to the default settings, this mode will be set

Parameter	[Plane]	[Glider]	[Acro plane]	[F3A plane]	[Heli]	[Car]	[Boat]
Start acceleration	1.5s	1.5s	1.5s	1.5s	20s	1.0s	1.0s
Response	normal	normal	fast (0.2s)	normal	normal	normal	normal
Direction mode	unidirectional	unidirectional	unidirectional	unidirectional	unidirectional	bidirectional	bidirectional
Brake (full stop)	off	hard (70%>100%,0.5s)	off	soft (30%>100%,1.5s)	off	proportional	off
Init point type	auto	auto	auto	auto	Fixed	auto	auto
Fix init point	1.1ms	1.1ms	1.1ms	1.1ms	1.1ms	1.1ms	1.1ms
Fix end point	1.9ms	1.9ms	1.9ms	1.9ms	1.9ms	1.9ms	1.9ms
Offset adjustment	100%	100%	100%	100%	100%	100%	100%
Dead time (proportional brake)	0.1s	0.1s	0.1s	0.1s	0.1s	0.1s	0.1s
Maximal value (proportional brake)	100%	100%	100%	100%	100%	100%	100%
Speed (proportional brake)	1.0s	1.0s	1.0s	1.0s	1.0s	1.0s	1.0s
Begin power (manual brake)	10%	10%	10%	10%	10%	10%	10%
End power (manual brake)	100%	100%	100%	100%	100%	100%	100%
Dead time (manual brake)	0.2sec	0.2sec	0.2sec	0.2sec	0.2sec	0.2sec	0.2sec
Speed (manual brake)	1.0sec	1.0sec	1.0sec	1.0sec	1.0sec	1.0sec	1.0sec
Timing	15°	15°	15°	15°	auto	15°	15°
Rotation	normal	normal	normal	normal	normal	normal	normal
Number of motor poles	10	10	10	10	10	10	10
Start power	auto+0%	auto+0%	auto+0%	auto+0%	auto+0%	auto+0%	auto+0%
PWM frequency	8kHz	8kHz	8kHz	8kHz	8kHz	8kHz	8kHz
Rotor gear	1.0	1.0	1.0	1.0	1.0	1.0	1.0
Accumulator type	Li-XX	Li-XX	Li-XX	Li-XX	Li-XX	Li-XX	Li-XX
Number of cells	Auto	Auto	Auto	Auto	Auto	Auto	Auto
Cut-off voltage per cell	3.2V	3.2V	3.2V	3.2V	3.2V	3.2V	3.2V
Off voltage (manual setting)	5.0V	5.0V	5.0V	5.0V	5.0V	5.0V	5.0V
Max. temperature	100 = 100°C	100 = 100°C	100 = 100°C	100 = 100°C	100 = 100°C	100 = 100°C	100 = 100°C
l_value (max. elapsed capacity)	32500mAh	32500mAh	32500mAh	32500mAh	32500mAh	32500mAh	32500mAh
Max. current	180.0A	180.0A	180.0A	180.0A	180.0A	180.0A	180.0A
Cut-off method	slow down	slow down	slow down	slow down	slow down	slow down	slow down
EX Bus control	off	off	off	off	off	off	off
Fail-Safe delay	0.3s	0.3s	0.3s	0.3s	0.3s	0.3s	0.3s
Fail-Safe mode	motor-off	motor-off	motor-off	motor-off	motor-off	motor-off	motor-off
Fail-Safe value	-100%	-100%	-100%	-100%	-100%	-100%	-100%
BEC voltage	5.0V	5.0V	5.0V	5.0V	5.0V	5.0V	5.0V
Stop motor beep mode	off	off	off	off	off	off	off
Filtering type	standard motors	standard motors	standard motors	standard motors	standard motors	standard motors	standard motors
Elapsed capacity protection	disable	disable	disable	disable	disable	disable	disable
Governor	disabled	disabled	disabled	disabled	disabled	disabled	disabled
Motor KV	unknown	unknown	unknown	unknown	known	unknown	unknown
Motor KV value	0	0	0	0	530	0	0
MAX rpm (gear out)	8000 rpm	8000 rpm	8000 rpm	8000 rpm	6000 rpm	8000 rpm	8000 rpm
Governor setting	auto+0%	auto+0%	auto+0%	auto+0%	auto+0%	auto+0%	auto+0%
Governor setting mode	user	user	user	user	user	user	user
Response (for governor)	2.0sec	2.0sec	2.0sec	2.0sec	2.0sec	2.0sec	2.0sec
Motor start point (for governor)	20%	20%	20%	20%	20%	20%	20%
Autorotating mode	auto	auto	auto	auto	auto	auto	auto
Autorot. expiration time	5s	5s	5s	5s	5s	5s	5s
Ri compensation	5mohm	5mohm	5mohm	5mohm	5mohm	5mohm	5mohm
F3A mode	disabled	disabled	disabled	disabled	disabled	disabled	disabled
Fly restart transition time	2sec	2sec	2sec	2sec	2sec	2sec	2sec

10.2. Dimensions of MEZON EVO controllers

MEZON EVO 40 LMR and MEZON EVO 70 LMR controller dimensions (mm)

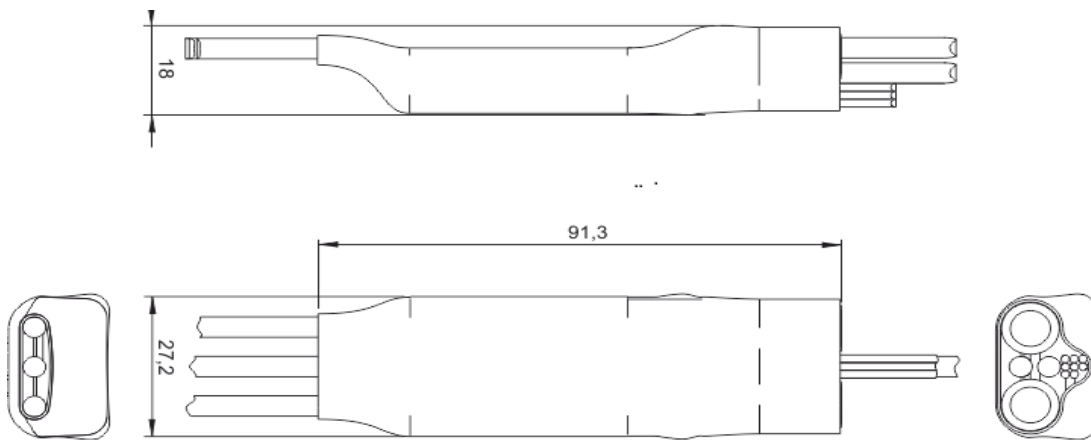

Dimensions of the MEZON EVO 50 BEC controller

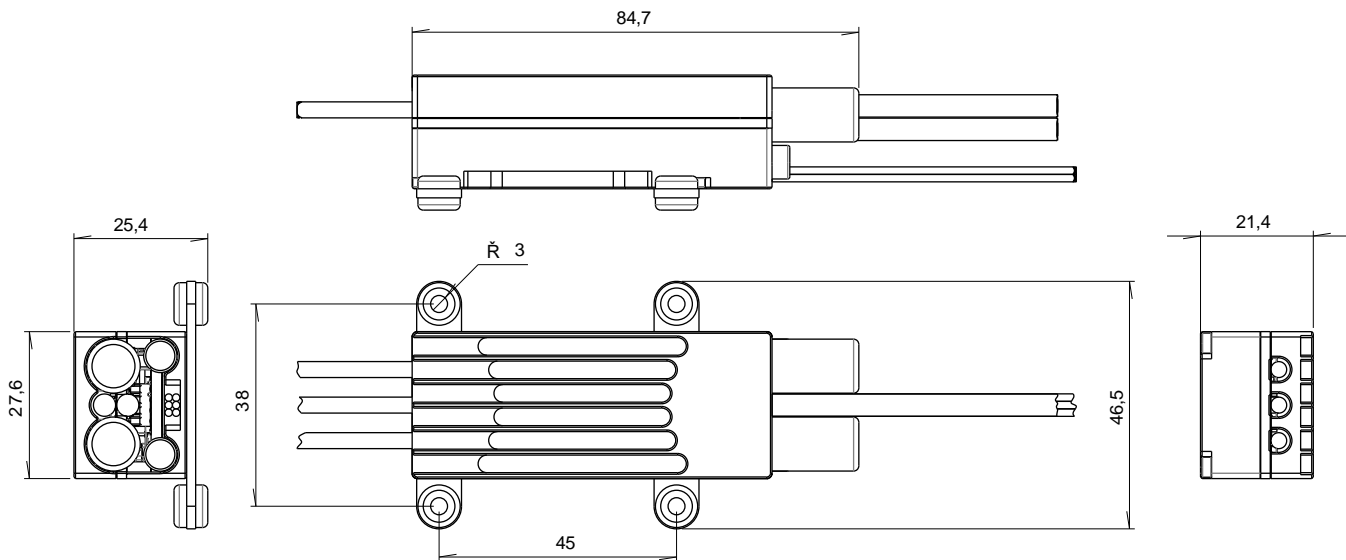

Dimensions of the MEZON EVO 80 BEC controller

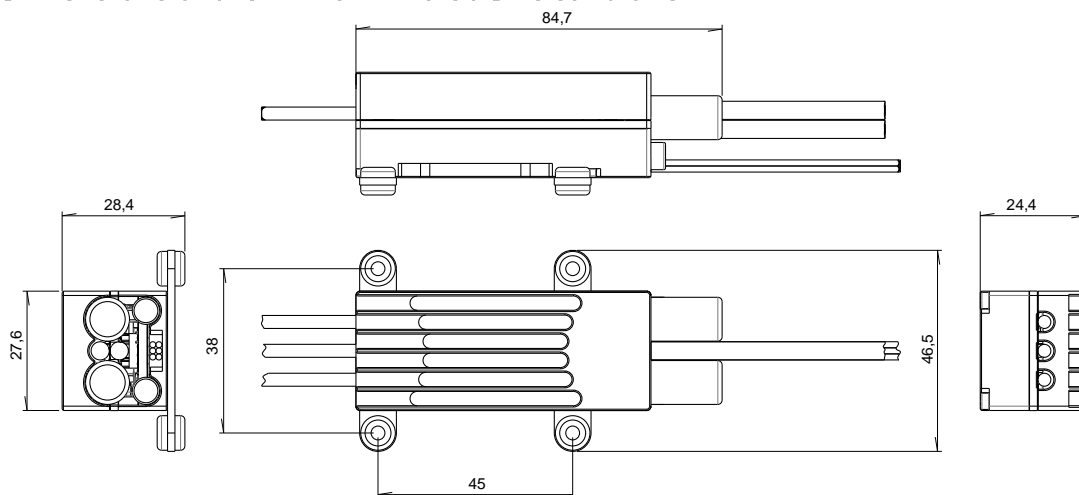

Dimensions of the MEZON EVO 85 OPTO controller

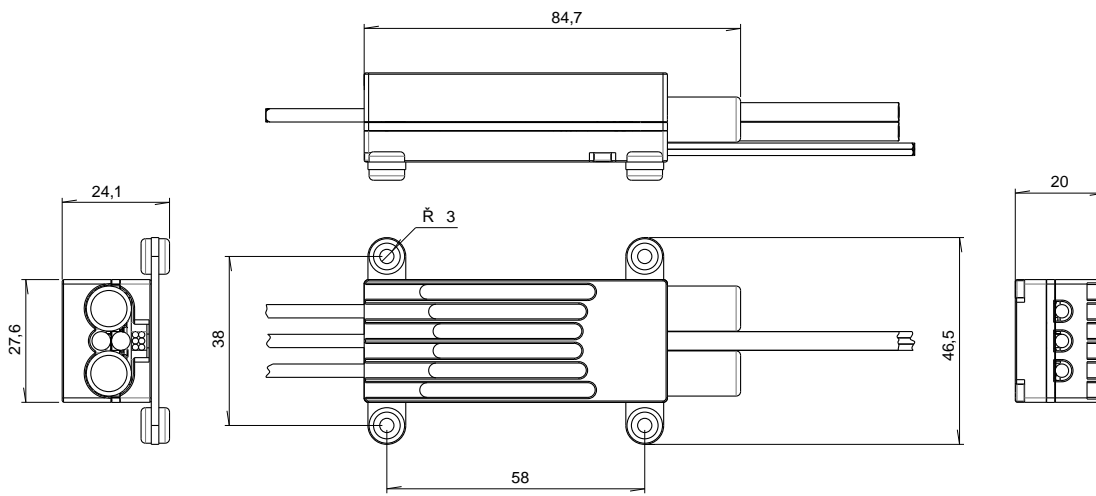

ENGLISH**Information on Disposal for Users of Waste Electrical & Electronic Equipment (private households)**



This symbol on the products and/or accompanying documents means that used electrical and electronic products should not be mixed with general household waste.

For proper treatment, recovery and recycling, please take these products to designated collection points, where they will be accepted on a free of charge basis. Alternatively, in some countries you may be able to return your products to your local retailer upon the purchase of an equivalent new product.

Disposing of this product correctly will help to save valuable resources and prevent any potential negative effects on human health and the environment which could otherwise arise from inappropriate waste handling. Please contact your local authority for further details of your nearest designated collection point.

Penalties may be applicable for incorrect disposal of this waste, in accordance with national legislation.

For business users in the European Union

If you wish to discard electrical and electronic equipment, please contact your dealer or supplier for further information.

Information on Disposal in other Countries outside the European Union

This symbol is only valid in the European Union.

If you wish to discard this product, please contact your local authorities or dealer and ask for the correct method of disposal.

Warranty and service

This product is covered by warranty for 24 months after the day of purchase provided that it has been operated in accordance with these instructions at the specified voltage and is not mechanically damaged. When claiming warranty repairs for the product, always attach a proof of purchase. Warranty and post-warranty service is provided by your dealer or the manufacturer.

Technical support

In case you are not sure about the setup or some functions of the product, do not hesitate to contact our technical support. You can contact either your dealer, or directly the manufacturer JETI model s.r.o. For further information see our webpages www.jetimodel.com

Safety instructions

- use quality power connectors designated for appropriate load current
- keep power supply within the allowed voltage/cell range
- set BEC voltage within servo producer instructions
- ensure sufficient air flow cooling
- isolate reliably all wires, conductors and connectors
- reverse polarity causes damage to controller with loss of warranty
- during controller configuration remove propeller or rotor blades
- treat model with respect, after connection of power supply motor/model is live. Risk of injury!



Declaration of Conformity

in accordance with the regulations of EU Directive
EMC 2014/30/EU, RoHS 2011/65/EU and (EU) 2015/863

This declaration of conformity is issued under the sole responsibility of the manufacturer.

Producer: **JETI model s.r.o.**
Lomená 1530, 742 58 Příbor, Česká republika
IČ 26825147

declares, that the product

Type designation: MEZON EVO
Model number: 40 BEC LMR, 50 BEC, 70 BEC LMR, 80 BEC, 85 OPTO

The stated product complies with essential requirements of EMC 2014/30/EU, RoHS Directive 2011/65/EU and (EU) 2015/863.

Harmonized standards apply:

Protection requirements concerning electromagnetic compatibility [6]

EN 61000-6-3:2007 + A1:2011

Electrical Safety and Health [3.1(a)]

EN 62368-1:2015

RoHS

EN 50581:2012

Příbor, 11.8.2022



Ing. Stanislav Jelen,
Managing Director